

9

LLAVES DE VASO
SOCKET WRENCHES
DOUILLES
STECKSCHLÜSSEL
BUSSOLE
CHAVES DE CAIXA
ГОЛОВКИ



El tener la llave de vaso o accesorio correcto cuando es requerido marca la diferencia. Por esta razón, EGA Master fabrica y mantiene en stock la gama más amplia de llaves de vaso y accesorios de calidad industrial:

Having the right socket wrench or accessory when required makes the difference. For this reason, EGA MASTER makes and keeps in stock the widest range of industrial quality socket wrenches and accessories:

Avoir la bonne douille ou le bon accessoire quand il est fait fait la différence. Pour cette raison, EGA Master fabrique et maintient en stock la plus large gamme de douilles et d'accessoires de qualité industrielle :

USO MANUAL
MANUAL USE
MANUEL D'UTILISATION

		Hexagonal Hexagonale	Hexagonal Hex	Bihex	Spline	E-torx	Articuladas Universal Articulées	Puntas atornilladoras con vaso Socket bits Embouts de vissage avec douille	Adaptador de par Torque adaptor Adaptateur de couple	Crow foot
1/4"	Standard Shallow/Short	mm	●	●	●	●	●	●		●
	Standard	inch	●	●	●		●	●		●
	Serie larga Deep/Long	mm	●	●				●		
	Série longue	inch	●	●				●		
3/8"	Standard Shallow/Short	mm	●	●		●	●	●	●	●
	Standard	inch	●	●			●	●	●	●
	Serie larga Deep/Long	mm	●	●				●		
	Série longue	inch	●	●				●		
1/2"	Standard Shallow/Short	mm	●	●	●	●	●	●		●
	Standard	inch	●	●	●		●	●		●
	Serie larga Deep/Long	mm	●	●				●		
	Série longue	inch	●	●				●		
3/4"	Standard Shallow/Short	mm	●	●						
	Standard	inch	●	●						
	Serie larga Deep/Long	mm	●	●						
	Série longue	inch	●	●						
1"	Standard Shallow/Short	mm	●	●						
	Standard	inch	●	●						
	Serie larga Deep/Long	mm	●	●						
	Série longue	inch	●	●						



IMPACTO
 IMPACT
 À CHOC

			Hexagonal Hex Hexagonale	4 point	8 point	Puntas atornilladoras con vaso Socket bits Embouts de vissage avec douille
3/8"	Standard	mm	●			●
	Shallow/Short					
	Standard	inch	●			●
	Serie larga					
1/2"	Standard	mm	●			●
	Shallow/Short				●	
	Standard	inch	●		●	●
	Serie larga					
3/4"	Standard	mm	●	●		●
	Shallow/Short					
	Standard	inch	●	●	●	●
	Serie larga					
1"	Standard	mm	●	●		●
	Shallow/Short					
	Standard	inch	●	●	●	●
	Serie larga					
1.1/2"	Standard	mm	●			
	Shallow/Short					
	Standard	inch	●			
	Serie larga					
2.1/2"	Standard	mm	●			
	Shallow/Short					
	Standard	inch	●			
	Serie larga					
3.1/2"	Standard	mm	●			
	Shallow/Short					
	Standard	inch	●			
	Serie larga					



■ 1/4"

■ STANDARD

■ MM

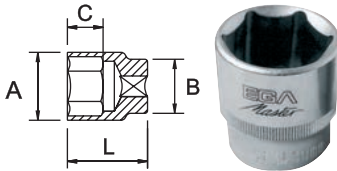

COD.	AF [±] mm	L (mm)	A (mm)	B (mm)	C (mm)	Pt	g	Icon 1	Icon 2
61322	3,2		6		7				
61311	4		7		8				
63974	4,5		7			9		30	
61312	5		8						
63975	5,5		9	12					
61313	6		9		9		10		
61314	7		11						•
61315	8	x	12			6	12	25	
61316	9		13				13		
61317	10		15	13			15		
61318	11		16	14			17		
61319	12		17		13		20		20
61320	13		18	15					
61321	14		17				23		



CARACTERÍSTICAS / FEATURES / CARACTÉRISTIQUES

Cr-V

■ INCH

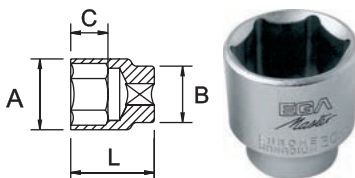

COD.	AF [±] inch	L (mm)	A (mm)	B (mm)	C (mm)	Pt	g	Icon 1	Icon 2
60420	5/32		7		9	9		30	
60421	3/16		9			10			
60422	7/32		9,5	12	11		12		
60423	1/4		11				13	25	
60424	9/32		12			6			•
60425	5/16	y	14	14			15		
60426	11/32		16	16	12		16		20
60427	3/8		18	18			21		
60428	7/16		20	20	13		27		
60429	1/2						34		
60430	9/16								



CARACTERÍSTICAS / FEATURES / CARACTÉRISTIQUES

Cr-V

■ MM

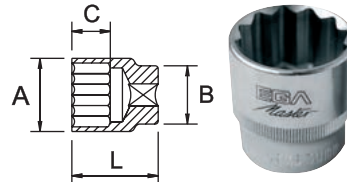

COD.	AF [±] mm	L (mm)	A (mm)	B (mm)	C (mm)	Pt	g	Icon 1	Icon 2
63977	5		8			9		30	
63978	5,5		9			10			
63979	6		11	12	9		12		25
63980	7		12				13		
63981	8		13			12			
63982	9	x	15	13		12	13		•
63983	10		16	14			15		
63984	11		17		13		17		20
63985	12		18	15			20		
63986	13		17				23		
63987	14								



CARACTERÍSTICAS / FEATURES / CARACTÉRISTIQUES

Cr-V

■ INCH

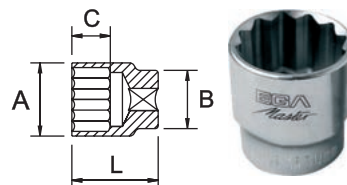

COD.	AF [±] inch	L (mm)	A (mm)	B (mm)	C (mm)	Pt	g	Icon 1	Icon 2
63989	3/16		7		9	9		30	
63990	7/32		9			10			
63991	1/4		9,5	12	11		12		
63992	9/32		11				13	25	
63993	5/16		12			12			•
63994	11/32	y	14	14			15		
63995	3/8		16	16	12		16		20
63996	7/16		18	18			21		
63997	1/2		20	20	13		27		
63998	9/16						34		



CARACTERÍSTICAS / FEATURES / CARACTÉRISTIQUES

Cr-V

x 50% cromado aeroespacial - 50% cromado pulido espejo / 50% aerospace chrome plating - 50% mirror polished chrome plating / 50% chromée aérospatiale - 50% polie chromée
y 100% cromado pulido espejo / 100% mirror polished chrome plating / 100% polie chromée

1/4"

SERIE LARGA / LONG SOCKETS / SÉRIE LONGUE / LANGE SERIE / SERIE LUNGA / SERIE LONGA / ВЫСОКАЯ СЕРИЯ

■ MM

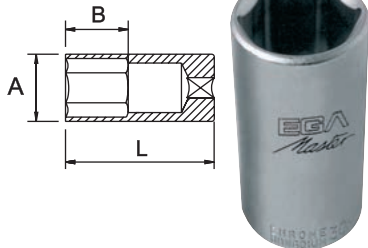

COD.	AF mm	L (mm)	A (mm)	B (mm)	Pt	g		
67640	4		7	10	20			
67641	4,5				21			
67642	5		8		23			
67643	5,5		9	11	24			
67644	6		9,5	14	26			
67645	7		11		27			
67646	x 8	50	12	19	6	27	10	●
67647	9		13	20	37			
67648	10		15	20	39			
67649	11		16	22	46			
67650	12		17		50			
67651	13		18	23	55			
67652	14		20		75			

○ I DIN 3124

CARACTERÍSTICAS / FEATURES / CARACTÉRISTIQUES

Cr-V

■ MM

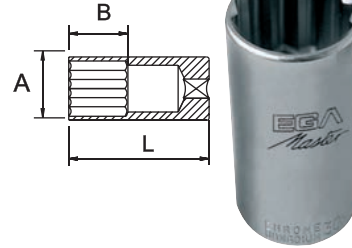

COD.	AF mm	L (mm)	A (mm)	B (mm)	Pt	g		
67660	5		8		23			
67661	5,5		9	11	24			
67662	6		9,5	14	26			
67663	7		11		27			
67664	8		12	19	27			
67665	x 9	50	13	20	12	37	10	●
67666	10		15		39			
67667	11		16	22	46			
67668	12		17		50			
67669	13		18	23	55			
67670	14		20		75			

○ I DIN 3124

CARACTERÍSTICAS / FEATURES / CARACTÉRISTIQUES

Cr-V

■ INCH

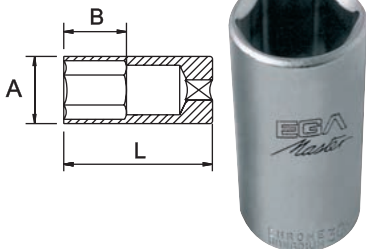

COD.	AF inch	L (mm)	A (mm)	B (mm)	Pt	g		
67674	5/32		7	8	22			
67675	3/16		8	11	24			
67676	7/32		9					
67677	1/4		9,5	14				
67678	9/32		11	18	28			
67679	y 5/16	50	12		6	28	10	●
67680	11/32		13	20	30			
67681	3/8				44			
67682	7/16		16		45			
67683	1/2			22	55			
67684	9/16		20	26	70			

○ I DIN 3124

CARACTERÍSTICAS / FEATURES / CARACTÉRISTIQUES

Cr-V

■ INCH

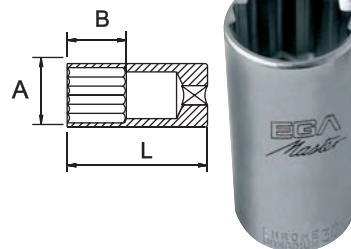

COD.	AF inch	L (mm)	A (mm)	B (mm)	Pt	g		
67689	5/32		7	8	22			
67690	3/16		8	11	24			
67691	7/32		9					
67692	1/4		9,5	14				
67693	9/32		11	18	28			
67694	y 5/16	50	12		12	28	10	●
67695	11/32		13	20	30			
67696	3/8				44			
67697	7/16		16		45			
67698	1/2			22	55			
67699	9/16		20	26	70			

○ I DIN 3124

CARACTERÍSTICAS / FEATURES / CARACTÉRISTIQUES

Cr-V

x 50% cromado aeroespacial - 50% cromado pulido espejo / 50% aerospace chrome plating - 50% mirror polished chrome plating / 50% chromée aérospatiale - 50% polie chromée
y 100% cromado pulido espejo / 100% mirror polished chrome plating / 100% polie chromée

1/4"

TORX®*

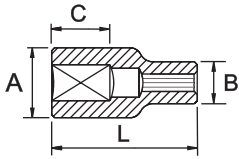

COD.		L (mm)	A (mm)	B (mm)	C (mm)			
57165	E4	25	7	12	6	11	25	●
57166	E5		8		8	12		
57167	E6		9		8	13		
57168	E7		10		9	14		
57169	E8		11		9	16		
57170	E10		13					



SPLINE

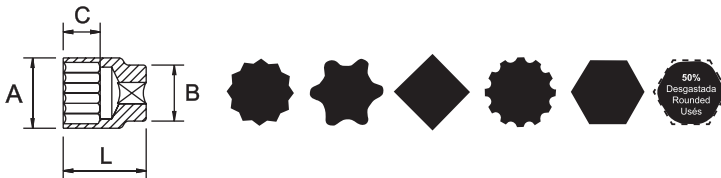

COD.					L (mm)	A (mm)	B (mm)	C (mm)			
56015	M5	5/32	4	E5	25	7	12	10	14	30	●
56017	M6	-	5	E6		8					
56018	M7	7/32	5,5	-		8,5					
56019	-	-	6	-		9					
55813	-	1/4	-	-		10,5					
56020	M9	9/32	7	-		10					
56021	y M10	5/16	8	E10	13	13	10	20	20	25	
56023	-	-	10	-	16	16	23	25			
55814	-	3/8	-	-	18	18	27	20			
56024	M14	7/16	11	E14	19	19	30	20			
56025	M15	-	12	E16	20	20	33				
56026	M16	1/2	13	-							
56027	M18	-	14	E18							



DIN 3120

CARACTERÍSTICAS / FEATURES / CARACTÉRISTIQUES

Cr-V

*Para tornillos TORX® (Marca registrada por Acument Intellectual Properties, LLC, Troy, Mich., US) / *For screws TORX® (Acument Intellectual Properties, LLC, Troy, Mich., US registered trademark) / *Pour vis TORX® (Marque enregistrée par Acument Intellectual Properties, LLC, Troy, Mich., US)

y 100% cromado pulido espejo / 100% mirror polished chrome plating / 100% polie chromée

1/4"

EXTRACTOR DE TUERCAS DESGASTADAS HASTA EL 50% / SCREW EXTRACTOR FOR 50% ROUNDED OFF NUTS / EXTRACTEUR D'ÉCROUS USÉS JUSQU'À 50% / AUSZIEHER 50%
 ABGENUTZTE MUTTER / ESTRATTORE PER DADI SPANATI FINO AL 50% / EXTRACTOR DE PORCAS DESGASTADAS ATÉ 50% / СЪЁМНИК ДЛЯ СВЕРНУТЫХ НА 50% ГАЕЕК

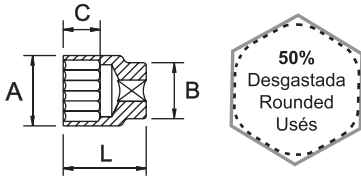

COD.	AF mm	L (mm)	A (mm)	B (mm)	C (mm)	g		
56015	4			7				
56017	5			8				
56018	5,5		12	8,5		10	30	
56019	6			9				
56020	7			10,5				
56021	8	25	13	13	10	14	25	•
56023	10		16	16		23		
56024	11							
56025	12		18	18		27	20	
56026	13		19	19		30		
56027	14		20	20		33		

DIN 3120

CARACTERÍSTICAS / FEATURES / CARACTÉRISTIQUES

Cr-V



LLAVES DE VASO ARTICULADAS / UNIVERSAL SOCKET / DOUILLES ARTICULÉES / STECKSCHLÜSSELGELENK / CHIAVE A BUSSOLA ARTICOLATA / CHAVES DE CAIXA ARTICULADAS / УНИВЕРСАЛЬНАЯ ГОЛОВКА С ШАРНИРОМ

MM

COD.	AF mm	L (mm)	g		
57279	6				
57280	7				
57281	8	34	23		
57282	9				
57283	10			10	•
57284	11				
57285	12	37	56		
57286	13				
57287	14				



INCH





COD.	AF inch	L (mm)	g		
57288	1/4				
57289	5/16	34	23		
57290	3/8			10	•
57291	7/16	37	56		
57292	1/2				





x 50% cromado aeroespacial - 50% cromado pulido espejo / 50% aerospaceal chrome plating - 50% mirror polished chrome plating / 50% chromée aérospatiale - 50% polie chromée
 y 100% cromado pulido espejo / 100% mirror polished chrome plating / 100% polie chromée

1/4"

PUNTAS ATORNILLADORAS CON VASO / SOCKET BITS / EMBOUTS DE VISSAGE AVEC DOUILLE / STECKSCHLÜSSELEINSATZ / INSERTI A BUSSOLA / PONTAS APARAFUSADORAS COM CAIXA / ГОЛОВКИ-БИТЫ
PLANA / FLAT / À FENTE / FLACH / РИАТТА / PLANA / ПЛОСКАЯ

COD.		L (mm)			
66733	0,8 x 4				
66734	1 x 5,5	37	15	10	●
66735	1,2 x 6,5				
66736	1,2 x 8				





PHILIPS

COD.		L (mm)			
66737	PH-1				
66738	PH-2	37	15	10	●
66739	PH-3				





POZIDRIV®*

COD.		L (mm)			
66740	PZ-1				
66741	PZ-2	37	15	10	●
66742	PZ-3				

HEXAGONAL / HEXAGONAL / HEXAGONALE / HEXAGONAL / ESAGONALE / HEXAGONAL / ШЕСТИГРАННАЯ
MM

COD.		L (mm)			
55697	1,5				
55698	2				
66743	3				
55699	3,5				
66744	4	37	15	10	●
66745	5				
55700	5,5				
66746	6				
67164	7				
66747	8				

INCH

COD.		L (mm)			
55670	1/16				
55671	5/64				
55672	3/32				
55673	7/64				
55674	1/8	37	15	10	●
55675	9/64				
55676	5/32				
55677	3/16				
55678	7/32				
55679	1/4				



*Para tornillos POZIDRIV® (Marca registrada por European Ind. Serv. Ltd.) / *For screws POZIDRIV® (European Ind. Serv. Ltd. registered trademark) / *Pour vis POZIDRIV® (Marque enregistrée par European Ind. Serv. Ltd.)

1/4"

TORX®*

COD.		L (mm)			
66729	T-6			15	
66730	T-7				
66748	T-8				
66749	T-9				
66750	T-10				
66751	T-15	37	15		●
66752	T-20			10	
66753	T-25				
66754	T-27				
66755	T-30				
66756	T-40				



SET

COD.		inch	PCS.			COD. PCS.	Composición / Composition / Composition
66757			12	250		66733, 66734, 66735, 66736, 66737, 66738, 66739, 66743, 66744, 66745, 66746, 66747	0,8 x 4 - 1 x 5,5 - 1,2 x 6,5 - 1,2 x 8 mm - PH-1 - PH-2 - PH-3 - HEX-3 - HEX-4 - HEX-5 - HEX-6 - HEX-8
66758	1/4				1	66733, 66734, 66735, 66736, 66740, 66741, 66742, 66743, 66744, 66745, 66746, 66747	0,8 x 4 - 1 x 5,5 - 1,2 x 6,5 - 1,2 x 8 mm - PZ-1 - PZ-2 - PZ-3 - HEX-3 - HEX-4 - HEX-5 - HEX-6 - HEX-8
66759			9	200		66748, 66749, 66750, 66751, 66752, 66753, 66754, 66755, 66756	T-8 - T-9 - T-10 - T-15 - T-20 - T-25 - T-27 - T-30 - T-40



ADAPTADOR / ADAPTER / ADAPTATEUR / VERBINDUNGSTEIL / ADATTATORE / REDUTOR / АДАПТЕР

COD.		inch		inch			
65880		1/4-3/8			15	6	●



ADAPTADOR CON RETÉN / RETAINER ADAPTER / ADAPTATEUR AVEC RETENUE / ADAPTOR FÜR STECKSCHLÜSSEL / ADATTATORE CON BLOCCAGGIO / ADAPTADOR DE RETENÇÃO PARA CHAVES DE CAIXA / ПЕРЕХОДНИК-ФИКСАТОР 1/4»ПАПА НА 1/4»МАМА ДЛЯ ГОЛОВКИ

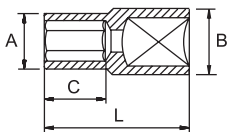

COD.		inch		inch	L (mm)	A (mm)	B (mm)	C (mm)			
65846		1/4-1/4			25	11	12	11	12	10	●



*Para tornillos TORX® (Marca registrada por Acument Intellectual Properties, LLC, Troy, Mich., US) / *For screws TORX® (Acument Intellectual Properties, LLC, Troy, Mich., US registered trademark) / *Pour vis TORX® (Marque enregistrée par Acument Intellectual Properties, LLC, Troy, Mich., US)

1/4"

LLAVE FIJA CROW FOOT / OPEN END CROW FOOT WRENCH / CLÉ À FOURCHE CROW FOOT / EINSTECK-MAULSCHLÜSSEL / CHIAVE FISSA CROW FOOT / PONTEIRA DE BOCA COM QUADRADO INTERIOR / РОЖКОВЫЙ КЛЮЧ С КВАДРАТОМ

■ MM

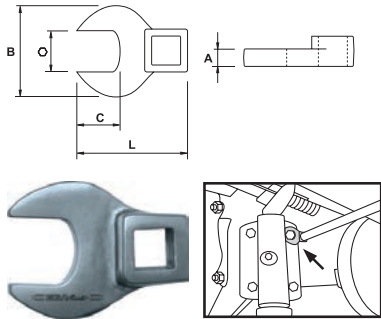

■ INCH

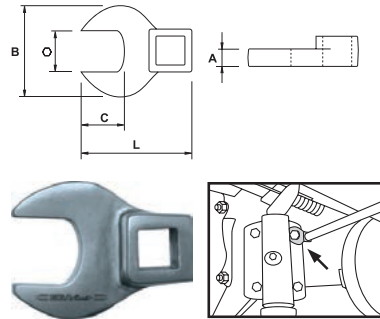

COD.	AF mm	L (mm)	A (mm)	B (mm)	C (mm)	g		
57211	7	30		25	6	70		
57212	8	31	6	26	7	75	10	●
57213	9	33		28	8			
57214	10	35		30	9	90		
57215	11	36		31	11			
57216	12	38	7	34	12	95		
57217	13	39			35			

COD.	AF inch	L (mm)	A (mm)	B (mm)	C (mm)	g		
57218	5/16	31		26	7	70		
57219	3/8	33	6	28	8	75	10	●
57220	7/16	35		30	9			
57221	1/2	38		34	12	92		
57222	9/16	39		36	14			

DESTORNILLADOR PORTAVASOS 1/4" / 1/4" SOCKET HOLDER / TOURNEVIS PORTE-DOUILLE 1/4" / 1/4" STECKSCHLÜSSEL-HALTER / CACCIAVITE PORTA BUSSOLA 1/4" / APARAFUSADOR PORTA CHAVES CAIXA 1/4" / 1/4" ДЕРЖАТЕЛЬ ГОЛОВКИ

COD.	AF inch	L (mm)	g		
66732	1/4	180	95	6	●



DESTORNILLADOR PORTAPUNTAS MAGNÉTICO / MAGNETIC BITHOLDER SCREWDRIVER / TOURNEVIS PORTE-EMBOUITS MAGNÉTIQUE / MAGNETISCHER BITHALTER-SCHRAUBENDREHER / CACCIAVITE PORTA INSERTI MAGNETICOM / CHAVE PORTA PONTAS MAGNETICO / ОТВЕРТКА С МАГНИТНЫМ БИТОДЕРЖАТЕЛЕМ

COD.	inch	L (mm)	g		
66731	1/4	215	105	6	●



COD.	inch	L (mm)	g		
76737	1/4	210	120	6	●



1000V IEC 60900

LLAVE DE CARRACA REVERSIBLE / REVERSIBLE RATCHET HANDLE / CLÉ À CLIQUET RÉVERSIBLE / UMSCHALTKNARRE / CHIAVE A CRICCO REVERSIBILE / ROQUETE REVERSIVEL / РЕВЕРСИВНАЯ ТРЕЩЕТКА

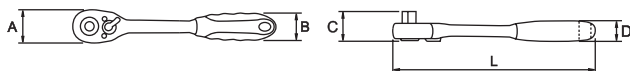

COD.	AF inch	L (mm)	A (mm)	B (mm)	C (mm)	D (mm)	g		
62603	1/4	140	23	21	22	17	105	6	●

DIN 3122

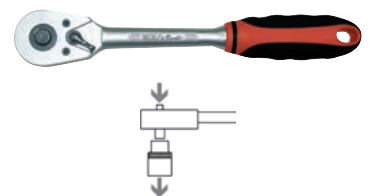

1/4"

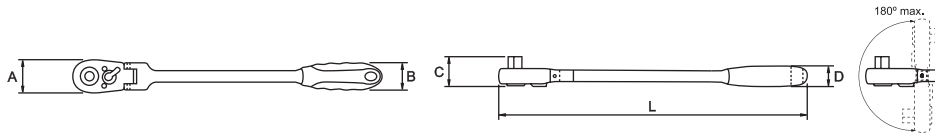

COD.	AF inch	L (mm)	A (mm)	B (mm)	C (mm)	D (mm)	g		
57411	1/4	160	22	21	23	17	120	6	●

DIN 3122

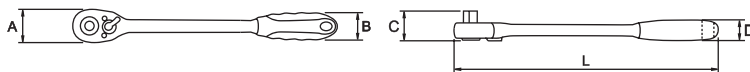

COD.	AF inch	L (mm)	A (mm)	B (mm)	C (mm)	D (mm)	g		
57414	1/4	180	23	21	21	17	150	6	●

DIN 3122



■ **MANGO CORREDIZO EN "T" / SLIDING "T" HANDLE / POIGNÉE COULISSANTE / QUERGRIF / ASTA CON QUADRO SCORREVOLO / CABO "T" CORREDIÇO / ПОДВИЖНАЯ "Т" РУЧКА**

COD.	AF inch	L (mm)	g		
61438	1/4	115	60	5	●

DIN 3122



■ **ARTICULACIÓN UNIVERSAL / UNIVERSAL JOINT / CARDAN UNIVERSEL / KARDANGELNENK / SNODO CARDANICO / CARDAN UNIVERSAL / ШАРНИР**

COD.	AF inch	g		
61435	1/4	30	10	●

DIN 3123



■ **ALARGADERA / EXTENSION / RALLONGE / VERLÄNGERUNG / PROLUNGA / EXTENÇÃO / УДЛИНИТЕЛЬ**

COD.	AF inch	L (inch)	g		
61442	1/4	2	25	5	●
61454		3	35		
61443		4	45		
61444		6	65		
62731		10	110		

DIN 3123



■ **BERBIQUÍ / SPEEDER HANDLE / VILEBREQUIN / KURBEL / LEVA GIROBECCHINO / MANIVELA / КОЛЕНЧАТАЯ РУЧКА**

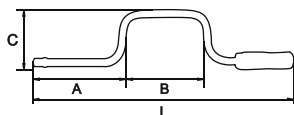

COD.	AF inch	L (mm)	A (mm)	B (mm)	C (mm)	g	
61408	1/4	425	130	145	100	450	5

DIN 3122



■ **ALARGADERA FLEXIBLE / FLEXIBLE HANDLE / RALLONGE FLEXIBLE / GELENK-STECKGRIF / PROLUNGA FLESSIBILE / EXTENSÃO FLEXÍVEL / ГИБКАЯ РУКОЯТКА**

COD.	AF inch	L (inch)	g	
61445	1/4	6	60	5

DIN 3122



MANGO ARTICULADO / SWIVEL HANDLE / MANCHE ARTICULÉ / GELENKGRIF / IMPUGNATURA SNODABILE / CABO ARTICULADO / РУЧКА С ШАРНИРОМ

COD.	AF inch	L (mm)	g		
65874	1/4	150	260	5	●



■ 3/8"

■ STANDARD

■ MM

■ MM

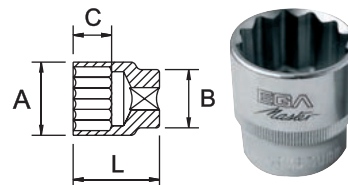
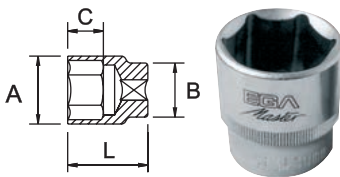

COD.	AF mm	L (mm)	A (mm)	B (mm)	C (mm)	Pt	g		
67541	6		10		9		20		
67542	7		11						
67543	8		12				24	25	
67544	9		14	17					
67545	10		15		10				
67546	11		16				25		
67547	12								
67548	13		18				28	20	
67549	14	28	20	18	12		32		
67550	x 15		21	19	14	6		15	●
67551	16		22		14		48		
67552	17		24	21					
67553	18		25	22			55	12	
67554	19		26		15				
67555	20		28						
67556	21		28	26			80	10	
67557	22		30						
67558	23	32	32	28	17		100		
67559	24								

COD.	AF mm	L (mm)	A (mm)	B (mm)	C (mm)	Pt	g		
67539	6		10		9		20		
67540	7		11						
61343	8		12						
61344	9		14	17			24	25	
61345	10		15		10				
61346	11		16				25		
61347	12								
61348	13		18				28	20	
61349	14	28	20	18	12		32		
61350	x 15		21	19	14	12		15	●
61351	16		22		14		48		
61352	17		24	21					
61353	18		25	22			55	12	
61354	19		26		15				
61355	20		28						
61356	21		28	26			80	10	
61357	22		30						
67560	23	32	32	28	17		100		
67561	24								

⊗ DIN 3124

⊗ DIN 3124

CARACTERÍSTICAS / FEATURES / CARACTÉRISTIQUES

CARACTERÍSTICAS / FEATURES / CARACTÉRISTIQUES

Cr-V

Cr-V

3/8"

■ INCH

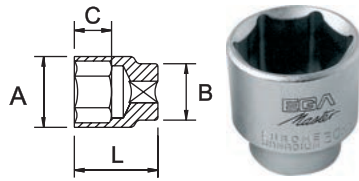

COD.	AF ^{inch}	L (mm)	A (mm)	B (mm)	C (mm)	Pt	g	Icon 1	Icon 2
67620	1/4		11						
67621	9/32					22			
67622	5/16		12	17					
67623	11/32		13		10	24	25		
67624	y 3/8	28	15			26			●
67625	7/16		16			30			
67626	1/2		18	18			20		
67627	9/16		20		12	31			

● I DIN 3124

CARACTERÍSTICAS / FEATURES / CARACTÉRISTIQUES

Cr-V

■ INCH

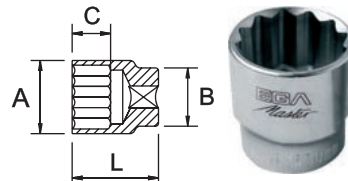

COD.	AF ^{inch}	L (mm)	A (mm)	B (mm)	C (mm)	Pt	g	Icon 1	Icon 2
60439	1/4		11			22			
60440	5/16		12						
60441	11/32		13	17		24	25		
60442	3/8		15		10	26			
60443	7/16	28	16			30			
60444	1/2		18	18		31	20		
60445	9/16		20		12	35			
60446	y 19/32		21	19	12	45	15		●
60447	5/8		22		13	50	12		
60448	11/16		24	23		60			
60449	3/4	30	26	24		75			
60450	13/16		28		17	80	10		
60451	7/8		30	28		90			
60452	15/16	32	32			100			
60453	1		34	30	20				

● I DIN 3124

CARACTERÍSTICAS / FEATURES / CARACTÉRISTIQUES

Cr-V

EGA Master

ART IN INNOVATION

y 100% cromado pulido espejo / 100% mirror polished chrome plating / 100% polie chromée

Si no encuentra el artículo que necesita, consúltenos en info@egamaster.com o en www.egamaster.com
If you can't find the item you look for, please ask us in info@egamaster.com or in www.egamaster.com
Si vous ne trouvez pas l'article que vous desirez, consultez-nous a info@egamaster.com ou a www.egamaster.com

3/8"

SERIE LARGA / LONG SOCKETS / SÉRIE LONGUE / LANGE SERIE / SERIE LUNGA / SERIE LONGA / ВЫСОКАЯ СЕРИЯ

■ MM

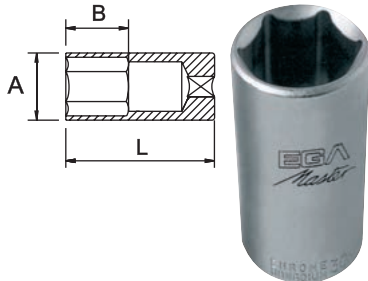

COD.	AF mm	L (mm)	A (mm)	B (mm)	Pt	g		
67705	7		11			41		
67706	8		12	16		42		
67707	9		13	18		50		
67708	10		15	20		55		
67709	11		17	24		70		
67710	12		19	25		80		
67711	13		20	27		85	10	●
67712	x 14	65	21		6	105		
67713	15		22			130		
67714	16		24			150		
67715	17		26	28		160		
67716	18		28			200		
67717	19		30	30				
67719	21							
67720	22							

● I DIN 3124

CARACTERÍSTICAS / FEATURES / CARACTÉRISTIQUES

Cr-V

■ MM

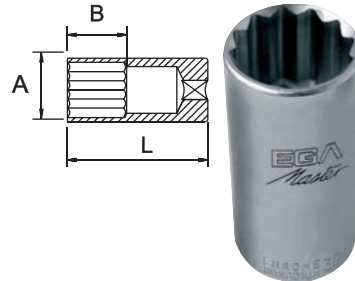

COD.	AF mm	L (mm)	A (mm)	B (mm)	Pt	g		
67725	7		11			41		
67726	8		12	16		42		
67727	9		13	18		50		
67728	10		15	20		55		
67729	11		17	24		70		
67730	12		19	25		80		
67731	13		20	27		85	10	●
67732	x 14	65	21		12	105		
67733	15		22			130		
67734	16		24			150		
67735	17		26	28		160		
67736	18		28			200		
67737	19		30	30				
67738	20							
67739	21							
67740	22							

● I DIN 3124

CARACTERÍSTICAS / FEATURES / CARACTÉRISTIQUES

Cr-V

■ INCH

COD.	AF inch	L (mm)	A (mm)	B (mm)	Pt	g		
67750	1/4		11	17		49		
67751	5/16		12	22		50		
67752	3/8		15	23		60		
67753	7/16		16			75		
67754	1/2		19	26		80		
67755	9/16		20			90	10	●
67756	y 19/32	65	21	27	12	100		
67757	5/8		22			135		
67758	11/16		23			165		
67759	3/4		26	28		190		
67760	13/16		28			230		
67761	7/8		30					
67762	15/16							

● I DIN 3124

CARACTERÍSTICAS / FEATURES / CARACTÉRISTIQUES

Cr-V

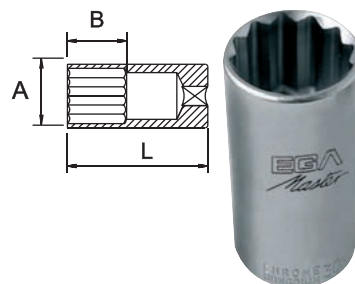

x 50% cromado aeroespacial - 50% cromado pulido espejo / 50% aerospace chrome plating - 50% mirror polished chrome plating / 50% chromée aérospatiale - 50% polie chromée
y 100% cromado pulido espejo / 100% mirror polished chrome plating / 100% polie chromée

3/8"

TORX®*

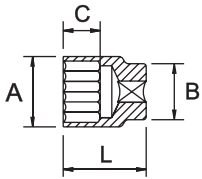

COD.		L (mm)	A (mm)	B (mm)	C (mm)			
57171	E8	28	12	17	10	25		
57172	E10		15					
57173	E11		16	18		30		
57174	E12					20		
57175	E14		18	19		38		
57176	E16					10		
57177	E18		29	22		51		
57178	E20		30	24		10		



LLAVES DE VASO ARTICULADAS / UNIVERSAL SOCKET / DOUILLES ARTICULÉES / STECKSCHLÜSSELGELENK / CHIAVE A BUSSOLA ARTICOLATA / CHAVES DE CAIXA ARTICULADAS / УНИВЕРСАЛЬНАЯ ГОЛОВКА С ШАРНИРОМ

MM



COD.		L (mm)			
57293	10	45	55		
57294	11	47	57		
57295	12		59		
57296	13	61			
57297	15		71		
57298	17	76			
57299	18		50		
57300	19	50	10		

INCH



COD.		L (mm)			
57301	3/8	46	55		
57302	7/16		57		
57303	1/2	47	59		
57304	9/16		65,5		
57305	5/8	71			
57306	11/16		50		
57307	3/4	51	76		



TORX®*

COD.		L (mm)			
57308	E8	46	56		
57309	E10				
57310	E12				
57311	E14				
57312	E16				



* Para tornillos TORX® (Marca registrada por Acument Intellectual Properties, LLC, Troy, Mich., US) / *For screws TORX® (Acument Intellectual Properties, LLC, Troy, Mich., US registered trademark) / *Pour vis TORX® (Marque enregistrée par Acument Intellectual Properties, LLC, Troy, Mich., US)





x 50% cromado aeroespacial - 50% cromado pulido espejo / 50% aerospace chrome plating - 50% mirror polished chrome plating / 50% chromée aérospatiale - 50% polie chromée

y 100% cromado pulido espejo / 100% mirror polished chrome plating / 100% polie chromée

3/8"





PUNTAS ATORNILLADORAS CON VASO / SOCKET BITS / EMBOUTS DE VISSAGE AVEC DOUILLE / STECKSCHLÜSSELEINSATZ / INSERTI A BUSSOLA / PONTAS APARAFUSADORAS COM CAIXA / ГОЛОВКИ-БИТЫ

PLANA / FLAT / À FENTE / FLACH / PIATTA / PLANA / ПЛОСКАЯ

COD.		L (mm)			
66760	1 x 5,5	48	35	10	●
66761	1,2 x 6,5				
66762	1,2 x 8				
66763	1,5 x 8				
66764	1,6 x 10				







PHILIPS

COD.		L (mm)			
66765	PH-1	48	35	10	●
66766	PH-2				
66767	PH-3				







POZIDRIV®*

COD.		L (mm)			
66768	PZ-1	48	35	10	●
66769	PZ-2				
66770	PZ-3				







HEXAGONAL / HEXAGONAL / HEXAGONALE / HEXAGONAL / ESAGONALE / HEXAGONAL / ШЕСТИГРАННАЯ

MM

COD.		L (mm)			
66771	3	48	35	10	●
55701	3,5				
66772	4				
66773	5				
55702	5,5				
66774	6				
66775	7				
66776	8				
55703	9,5				
66777	10				



INCH

COD.		L (mm)			
55680	1/8	48	35	10	●
55681	9/64				
55682	5/32				
55683	3/16				
55684	7/32				
55685	1/4				
55686	5/16				
55687	3/8				



09

LLAVES DE VASO
SOCKET WRENCHES
DOUILLES
STECKSCHLÜSSEL
BUSSOLE
CHAVES DE CAIXA
ГОЛОВКИ



3/8"

HEXAGONAL SERIE LARGA / HEXAGONAL LONG / HEXAGONALE SÉRIE LONGUE / HEXAGONAL LANG / ESAGONALO SERIE LUNGO / HEXAGONAL SÉRIE LONGA / ШЕСТИГРАННАЯ ВЫСОКАЯ

MM

COD.		L (mm)				
66778	4					
66779	5					
66780	6	92	70	10	●	
66781	8					
66782	10					

INCH

COD.		L (mm)				
56975	1/8		90			
56976	9/64					
56977	5/32		95			
56978	3/16		100			
56979	7/32	100	110	10	●	
56980	1/4		115			
56981	5/16		170			
56982	3/8		235			

HEXAGONAL PUNTA DE BOLA SERIE LARGA / HEXAGONAL BALL POINT LONG SERIE / HEXAGONALE EMBOUT SPHÉRIQUE SÉRIE LONGUE / HEXAGONAL KUGELKOPF LANG / ESAGONALE TESTA SFERICA SERIE LUNGO / HEXAGONAL PONTA ESFERICA SÉRIE LONGA / ШЕСТИГРАННАЯ С ШАРОВОЙ ГОЛОВКОЙ ДЛИННАЯ

COD.		L (mm)				
66783	4					
66784	5					
66785	6	92	70	10	●	
66786	8					
66787	10					

TORX®*

COD.		L (mm)				
66788	T-10					
66789	T-15					
66790	T-20					
66791	T-25					
66792	T-27	48	35	10	●	
66793	T-30					
66794	T-40					
66795	T-45					
66796	T-50					

N!

COD.		L (mm)				
58173	T-15					
58174	T-20					
58175	T-25					
58176	T-27	75	55	10	●	
58177	T-30					
58178	T-40					

*Para tornillos TORX® (Marca registrada por Acument Intellectual Properties, LLC, Troy, Mich., US) / *For screws TORX® (Acument Intellectual Properties, LLC, Troy, Mich., US registered trademark) / *Pour vis TORX® (Marque enregistrée par Acument Intellectual Properties, LLC, Troy, Mich., US)

Si no encuentra el artículo que necesita, consúltenos en info@egamaster.com o en www.egamaster.com
If you can't find the item you look for, please ask us in info@egamaster.com or in www.egamaster.com
Si vous ne trouvez pas l'article que vous desirez, consultez-nous a info@egamaster.com ou a www.egamaster.com

EGA Master
ART IN INNOVATION

347

3/8"

■ SET

COD.	AF inch	PCS.	g		COD. PCS.	Composición / Composition / Composition
66797	3/8	11	450		66760, 66761, 66762, 66763, 66764, 66765, 66766, 66767, 66768, 66769, 66770	1 x 5,5 - 1,2 x 6,5 - 1,2 x 8 - 1,5 x 8 - 1,6 x 10 mm - PH-1 - PH-2 - PH-3 - PZ-1 - PZ-2 - PZ-3
66798		12	650	1	66771, 66772, 66773, 66774, 66775, 66776, 66777, 66778, 66779, 66780, 66781, 66782	HEX-3 - HEX-4 - HEX-5 - HEX-6 - HEX-7 - HEX-8 - HEX-10 - HEX-4(L) - HEX-5(L) - HEX-6(L) - HEX-8(L) - HEX-10(L)
66799		9	350		66771, 66772, 66773, 66774, 66775, 66776, 66777, 66783, 66784, 66785, 66786, 66787	HEX-3 - HEX-4 - HEX-5 - HEX-6 - HEX-7 - HEX-8 - HEX-10 - HEX-4(L-B) - HEX-5(L-B) - HEX-6(L-B) - HEX-8(L-B) - HEX-10(L-B)
66800		9	350		66788, 66789, 66790, 66791, 66792, 66793, 66794, 66795, 66796	T-10 - T-15 - T-20 - T-25 - T-27 - T-30 - T-40 - T-45 - T-50



■ ADAPTADOR / ADAPTER / ADAPTATEUR / VERBINDUNGSTEIL / ADATTATORE / REDUTOR / АДАПТЕР

COD.	AF inch	AF inch	g		
65884	3/8-1/4		20	6	•
65881	3/8-1/2		45		



■ LLAVES DE VASO PARA BUJÍAS / SPARK PLUG SOCKETS / DOUILLES POUR BOUGIES / ZÜNDKERZEN - STECKSCHLÜSSEL / CHIAVI PER CANDELE / CHAVES DE CAIXA PA VELAS / ГОЛОВКИ ДЛЯ СВЕЧЕЙ ЗАЖИГАНИЯ

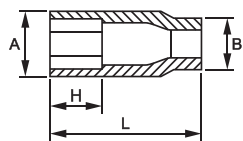

COD.	AF inch	AF mm	L (mm)	A (mm)	B (mm)	H (mm)	g		
61460	3/8	16	65	22	19	17	100	6	•
61461	3/8	21		28	22	20	150		



BE SAFE...BE EFFICIENT

3/8"

LLAVE FIJA CROW FOOT / OPEN END CROW FOOT WRENCH / CLÉ À FOURCHE CROW FOOT / EINSTECK-MAULSCHLÜSSEL / CHIAVE FISSA CROW FOOT / PONTEIRA DE BOCA COM QUADRADO INTERIOR / РОЖКОВЫЙ КЛЮЧ С КВАДРАТОМ

■ MM

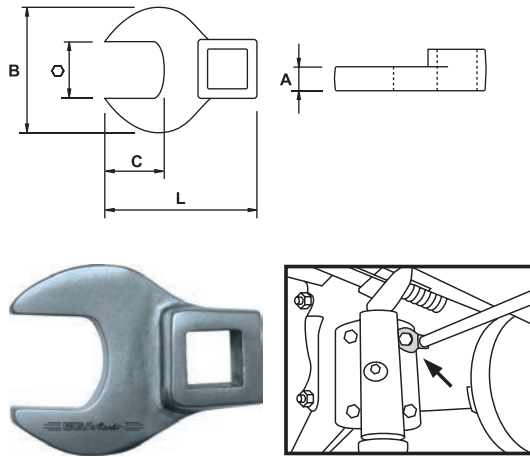

■ INCH

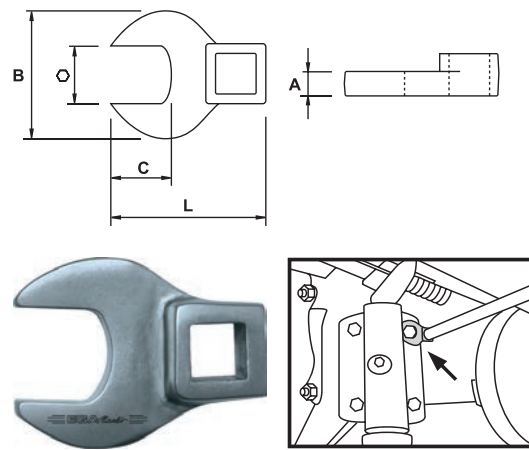

COD.	AF mm	L (mm)	A (mm)	B (mm)	C (mm)	g
55710	10	36	6	24	10	28
55711	11	39	6,5	26	13	35
55712	12	40	7,2	28	14	40
55713	13	42	8,3	30	15	41
55714	14	46	8,4	34	17	50
55715	15	48	8,8	36	18	56
55716	16	50	9	40	21	62
55717	17	55	9,5	46	22,5	80
55718	19	65	10	54	26,5	140
55719	21	75	11	64	30	180
55720	22	80	12	70	33	200
55721	24	90	14	80	38	250
55722	25	100	16	90	43	300
55723	27	110	18	100	48	350

COD.	AF inch	L (mm)	A (mm)	B (mm)	C (mm)	g
55724	3/8	36	6	24	10	28
55725	7/16	39	6,5	26	13	35
55726	1/2	40	7,2	28	14	40
55727	9/16	42	8,3	30	15	41
55728	5/8	46	8,4	34	17	50
55729	11/16	48	8,8	36	18	56
55730	3/4	50	9	40	21	62
55731	13/16	55	9,5	46	21,5	80
55732	7/8	60	10	50	22,5	100
55733	15/16	65	10,5	54	23,5	140
55734	1	70	11	60	24,5	180
55735	1.1/16	80	12	70	28,5	200

EGGA Master

ART IN INNOVATION

3/8"

LLAVE HEXAGONAL CROW FOOT / HEXAGONAL CROW FOOT WRENCH / CLÉ MÂLE CROW FOOT / SECHSKANT-EINSTECK-MAULSCHLÜSSEL / CHIAVE ESAGONALE CROW FOOT / PONTEIRA HEXAGONAL COM QUADRADO INTERIOR / РОЖКОВЫЙ ШЕСТИГРАННЫЙ КЛЮЧ С КВАДРАТОМ

MM

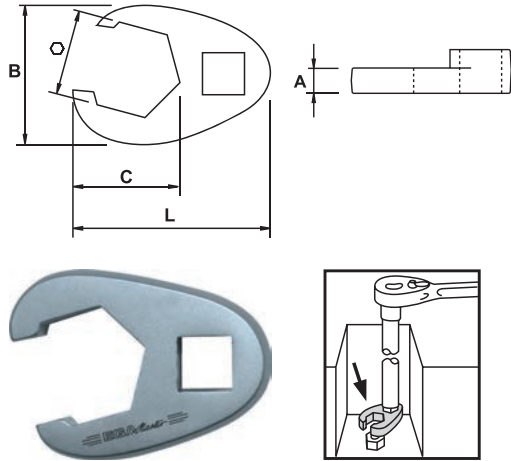

INCH

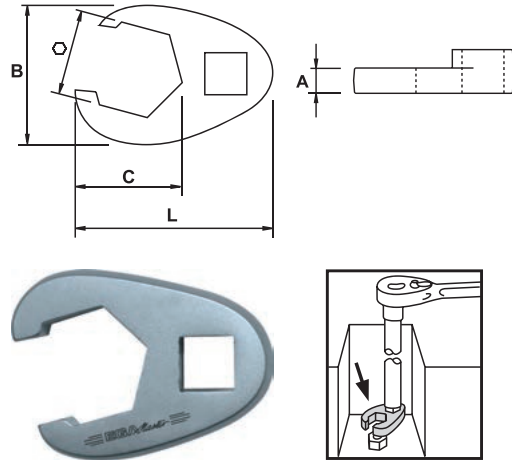

COD.	AF mm	L (mm)	A (mm)	B (mm)	C (mm)	g		
55736	10				16	28		
55737	11		7,8					
55738	12	38		31	18	35		
55739	13		8			40		
55740	14					41		
55741	15	41	9	33	21	50		
55742	16						10	●
55743	17	45			24	56		
55744	19	46	10,5	36	25	62		
55745	21					80		
55746	22	50	11	40	28,5	100		
55747	24					140		
55748	25	55	11,5	45	34			
55749	27					200		

COD.	AF inch	L (mm)	A (mm)	B (mm)	C (mm)	g		
55750	3/8				16	28		
55751	7/16	38	7,8	31	18	35		
55752	1/2		8			40		
55753	9/16	41	9	33	21	50		
55754	5/8							
55755	11/16	46	10,5	36	24	56		
55756	3/4				25	62	10	●
55757	13/16	50	11	40	28,5	80		
55758	7/8					100		
55759	15/16							
55760	1	55	11,5	45	34	140		
55761	1.1/16					200		

ADAPTADOR DE PAR / TORQUE ADAPTER / ADAPTATEUR DE COUPLE / DREHMOMENT ADAPTOR / ADATTATORE DI COPPIA / ADAPTADOR DE PAR / АДАПТЕР КРУТЯЩЕГО МОМЕНТА

MM

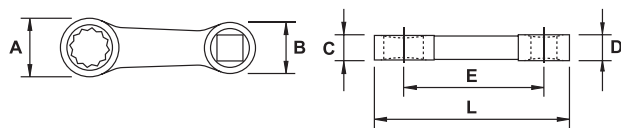

COD.	AF mm	AF inch	L (mm)	A (mm)	B (mm)	C (mm)	D (mm)	E (mm)	g		
57315	8			20	19	9	12	52	50		
57316	10	3/8	70	24	19	11,5	12	52	60	10	●
57317	13										



3/8"

INCH

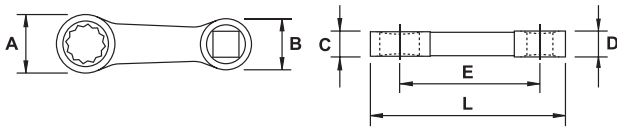

COD.	AF inch	AF inch	L (mm)	A (mm)	B (mm)	C (mm)	D (mm)	E (mm)	g		
57318	5/16										
57319	3/8			20		9		50			
57320	7/16	3/8	70		19		12	52		10	●
57321	1/2			24		12		60			
57322	9/16										



SPLINE

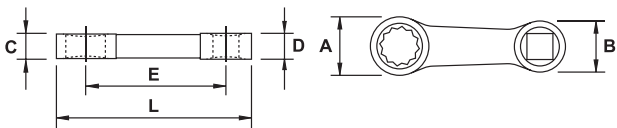

COD.	AF inch	AF inch		L (mm)	A (mm)	B (mm)	C (mm)	D (mm)	E (mm)	g		
57323	7/32		M7									
57324	1/4		M8									
57325	9/32		M9									
57326	5/16		M10		20		9		50			
57327	3/8	3/8	M12	70		19		12	52		10	●
57328	7/16		M14									
57329	1/2		M16									
57330	9/16		M18		24		12		60			
57331	5/8		M20									



LLAVE DE CARRACA REVERSIBLE / REVERSIBLE RATCHET HANDLE / CLÉ À CLIQUET RÉVERSIBLE / UMSCHALTKNARRE / CHIAVE A CRICCO REVERSIBILE / ROQUETE REVERSIVEL / РЕВЕРСИВНАЯ ТРЕЩЕТКА

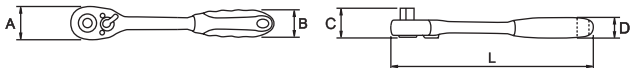

COD.	AF inch	L (mm)	A (mm)	B (mm)	C (mm)	D (mm)	g			
62604	3/8	200	31	28	29	22	270	6		●

DIN 3122

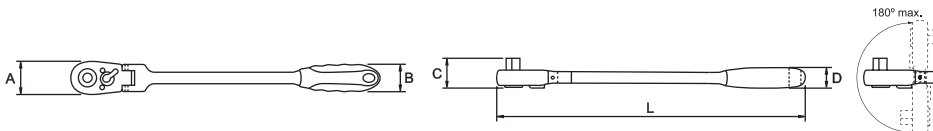
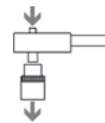

COD.	AF inch	L (mm)	A (mm)	B (mm)	C (mm)	D (mm)	g			
57412	3/8	300	29	28	30	22	390	6		●

DIN 3122

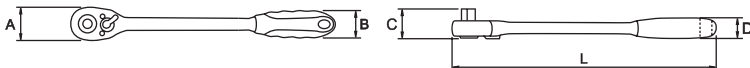

COD.	AF inch	L (mm)	A (mm)	B (mm)	C (mm)	D (mm)	g			
57415	3/8	280	31	28	29	22	370	6		●

DIN 3122



3/8"

MANGO CORREDIZO EN "T" / SLIDING "T" HANDLE / POIGNÉE COULISSANTE / QUERGRIF / ASTA CON QUADRO SCORREVOLO / CABO "T" CORREDIÇO / ПОДВИЖНАЯ "Т" РУЧКА

COD.	AF inch	L (mm)	g		
61439	3/8	165	180	5	●

DIN 3122

ARTICULACIÓN UNIVERSAL / UNIVERSAL JOINT / CARDAN UNIVERSEL / KARDANGELENK / SNODO CARDANICO / CARDAN UNIVERSAL / ШАРНИР

COD.	AF inch	g		
61436	3/8	80	10	●

DIN 3123

ALARGADERA / EXTENSION / RALLONGE / VERLÄNGERUNG / PROLUNGA / EXTENÇÃO / УДЛИНИТЕЛЬ

COD.	AF inch	L (inch)	g		
62732	3/8	2	50	5	●
61459		3	65		
61447		6	120		
61449		8	175		
61450		10	240		

DIN 3123

ALARGADERA FLEXIBLE / FLEXIBLE HANDLE / RALLONGE FLEXIBLE / GELENK-STECKGRIF / PROLUNGA FLESSIBILE / EXTENSÃO FLEXÍVEL / EXTENSÃO FLEXÍVEL / ГИБКИЙ УДЛИНИТЕЛЬ

N!

COD.	AF inch	L (inch)	g	
62118	3/8	8	180	5

DIN 3122

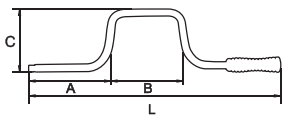
BERBIQUÍ / SPEEDER HANDLE / VILEBREQUIN / KURBEL / LEVA GIROBECCHINO / MANIVELA / КОЛЕНЧАТАЯ РУЧКА

COD.	AF inch	L (mm)	A (mm)	B (mm)	C (mm)	g	
61409	3/8	425	130	140	115	570	5

DIN 3122

MANGO ARTICULADO / SWIVEL HANDLE / MANCHE ARTICULÉ / GELENKGRIF / IMPUGNATURA SNODABILE / CABO ARTICULADO / РУЧКА С ШАРНИРОМ

COD.	AF inch	L (mm)	g		
65875	3/8	214	375	5	●



■ 1/2"
■ STANDARD
■ MM

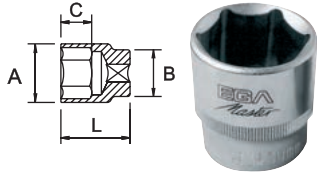

■ INCH

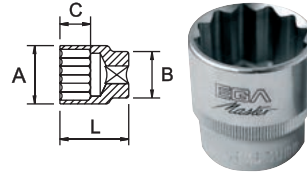

COD.	AF mm	L (mm)	A (mm)	B (mm)	C (mm)	Pt	g	Icon 1	Icon 2
61800	8		13				48		
61801	9		14		13				
61802	10		15				49		
61803	11		17						
61804	12		18					25	
61805	13		19	22			50		
61806	14		20						
61807	15		22		14		55		
61808	16	38					60		
61809	17		24				65		20
61810	18		26	23			75		
61811	19					6	80		●
61812	x 20		28	24	15			15	
61813			30				110		
61814			32	26					
61815		40			16		115		10
61816			34	28	18		130		
61817		41							
61818		42	36	30			165		8
61819			38		20				
61820		42			21				
61821		44	40	32	22				
61822			40				210		7
61823		45	42	38	26				

● | DIN 3124

CARACTERÍSTICAS / FEATURES / CARACTÉRISTIQUES

Cr-V

COD.	AF mm	L (mm)	A (mm)	B (mm)	C (mm)	Pt	g	Icon 1	Icon 2
61380	8		13				48		
61381	9		14		13				
61382	10		15				49		
61383	11		17						
61384	12		18					25	
61385	13		19	22			50		
61386	14		20						
61387	15		22		14		55		
61388	16	38					60		
61389	17		24				65		20
61390	18		26	23			75		
61391	19					12	80		●
61392	x 20		28	24	15			15	
61393			30				110		
61394			32	26					
61395		40			16		115		10
61396			34	28	18		130		
61397		41							
61398		42	36	30			165		8
61399			38		20				
61400		42			21				
61401		44	40	32	22				
61402			40				210		7
61403		45	42	38	26				

● | DIN 3124

CARACTERÍSTICAS / FEATURES / CARACTÉRISTIQUES

Cr-V

x 50% cromado aeroespacial - 50% cromado pulido espejo / 50% aerospace chrome plating - 50% mirror polished chrome plating / 50% chromée aérospatiale - 50% polie chromée

Si no encuentra el artículo que necesita, consúltenos en info@egamaster.com o en www.egamaster.com
If you can't find the item you look for, please ask us in info@egamaster.com or in www.egamaster.com
Si vous ne trouvez pas l'article que vous desirez, consultez-nous a info@egamaster.com ou a www.egamaster.com

1/2"

MM

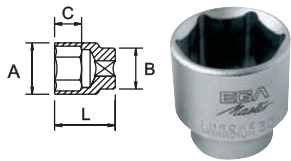

INCH

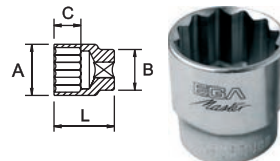

COD.	AF inch	L (mm)	A (mm)	B (mm)	C (mm)	Pt	g	Icon 1	Icon 2
60460	5/16		13			13	46		
60461	3/8		15				49		
60462	7/16		17				50		
60463	1/2		19					25	
60464	9/16		20	22			55		
60465	19/32		22		14				
60466	5/8	38							
60459	21/32		24				65		
60467	11/16		24				70	20	
60468	3/4		26	23					
60469	25/32		28	24		6	80		•
60470	13/16		28				85	15	
60471	7/8		30	25					
60472	15/16		32	26	18		95		
60473	31/32	40	33	28			125	10	
60474	1		34				135		
60475	1.1/16	42	36						
60476	1.1/8		38	32	19		185	8	
60477	1.3/16	44	40	22					
60478	1.1/4		42	34	23		210	7	

COD.	AF inch	L (mm)	A (mm)	B (mm)	C (mm)	Pt	g	Icon 1	Icon 2
60480	5/16		13			13	46		
60481	3/8		15				49		
60482	7/16		17				50		
60483	1/2		19					25	
60484	9/16		20	22			55		
60485	19/32		22		14				
60486	5/8	38							
60479	21/32		24				65		
60487	11/16		24				70	20	
60488	3/4		26	23					
60489	25/32		28	24		12	80		•
60490	13/16		28				85	15	
60491	7/8		30	25					
60492	15/16		32	26	18		95		
60493	31/32	40	33	28			125	10	
60494	1		34				135		
60495	1.1/16	42	36						
60496	1.1/8		38	32	19		185	8	
60497	1.3/16	44	40	22					
60498	1.1/4		42	34	23		210	7	

○ | DIN 3124

○ | DIN 3124

CARACTERÍSTICAS / FEATURES / CARACTÉRISTIQUES

Cr-V

CARACTERÍSTICAS / FEATURES / CARACTÉRISTIQUES

Cr-V

EGGA Master

ART IN INNOVATION

09

**LLAVES DE VASO
SOCKET WRENCHES
DOUILLES
STECKSCHLÜSSEL
BUSSOLE
CHAVES DE CAIXA
ГОЛОВКИ**



1/2"

■ **SERIE LARGA / LONG SOCKETS / SÉRIE LONGUE / LANGE SERIE / SERIE LUNGA / SERIE LONGA / ВЫСОКАЯ СЕРИЯ**

■ **MM**

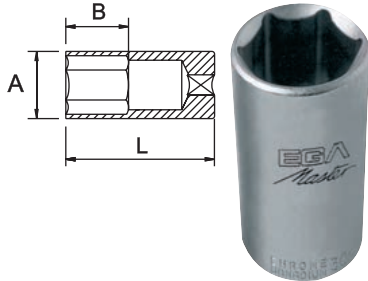

■ **INCH**

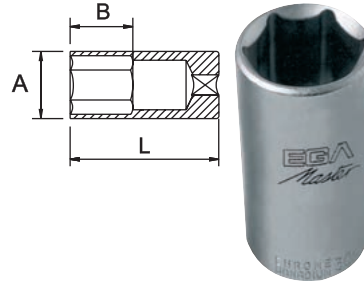

COD.	AF mm	L (mm)	A (mm)	B (mm)	Pt	g		
65044	10		16			110		
65045	11		17					
65046	12		18					
65047	13		19	22		115		
65048	14		21					
65049	15		22			125		
65050	16		22	26				
65051	17		24			130		
65052	18		24			150		
65053	19		26			165		
65054	x 21	75	28		6	180	10	•
65055	22		30			210		
65056	23		32			240		
65057	24		32	32		260		
67770	26		36			330		
67771	27		36			350		
67772	28		38			380		
67773	29		38			420		
67774	30		40			420		
67775	32		42			460		

○ | DIN 3124

CARACTERÍSTICAS / FEATURES / CARACTÉRISTIQUES

Cr-V

COD.	AF inch	L (mm)	A (mm)	B (mm)	Pt	g		
65064	3/8		15	24		105		
65065	7/16		17	24		115		
65066	1/2		19	27				
65067	9/16		21			120		
65068	5/8		22					
65069	y 11/16	75	24		6	125	10	•
65070	3/4		26	34		150		
65071	13/16		27			170		
65072	7/8		30			210		
65073	15/16		32			250		

○ | DIN 3124

CARACTERÍSTICAS / FEATURES / CARACTÉRISTIQUES

Cr-V

BE SAFE...BE EFFICIENT

x 50% cromado aeroespacial - 50% cromado pulido espejo / 50% aerospace chrome plating - 50% mirror polished chrome plating / 50% chromée aérospatiale - 50% polie chromée
y 100% cromado pulido espejo / 100% mirror polished chrome plating / 100% polie chromée

Si no encuentra el artículo que necesita, consúltenos en info@egamaster.com o en www.egamaster.com
If you can't find the item you look for, please ask us in info@egamaster.com or in www.egamaster.com
Si vous ne trouvez pas l'article que vous désirez, consultez-nous à info@egamaster.com ou à www.egamaster.com



1/2"

■ MM

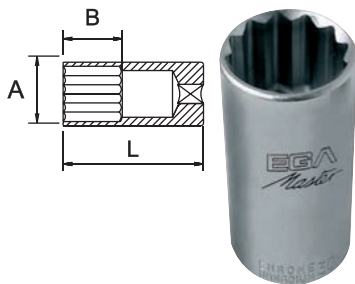

■ INCH

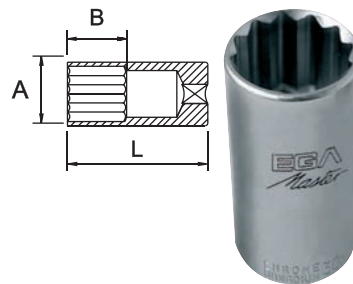

COD.	AF [±] mm	L (mm)	A (mm)	B (mm)	Pt	g		
67780	10		16			110		
67781	11		17					
67782	12		18					
67783	13		19	22		115		
67784	14		21					
67785	15		22			125		
67786	16		26					
67787	17		24			130		
67788	18		26			150		
67789	19		26			165		
67791	x 21	75	28		12	180	10	•
67792	22		30			210		
67793	23		32			240		
67794	24		32	32		260		
67795	26		36			330		
67796	27					350		
67797	28		38			380		
67798	29		40			420		
67799	30		40			420		
67800	32		42			460		

● I DIN 3124

CARACTERÍSTICAS / FEATURES / CARACTÉRISTIQUES

Cr-V

COD.	AF [±] inch	L (mm)	A (mm)	B (mm)	Pt	g		
67805	3/8		15	24		105		
67806	7/16		17	27		115		
67807	1/2		19	27				
67808	9/16		21			120		
67809	5/8		22					
67810	11/16		24			125		
67811	3/4	75	26		12	150	10	•
67812	y 13/16		27			170		
67813	7/8		30	34		210		
67814	15/16		32			250		
67815	1		34			280		
67816	1.1/16		36			330		
67817	1.1/8		38			370		
67818	1.1/4					455		

● I DIN 3124

CARACTERÍSTICAS / FEATURES / CARACTÉRISTIQUES





Cr-V

x 50% cromado aeroespacial - 50% cromado pulido espejo / 50% aerospace chrome plating - 50% mirror polished chrome plating / 50% chromée aérospatiale - 50% polie chromée
 y 100% cromado pulido espejo / 100% mirror polished chrome plating / 100% polie chromée

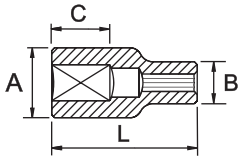
1/2"

■ TORX®*



COD.		L (mm)	A (mm)	B (mm)	C (mm)			
57179	E10	38	15	22	10	55	10	●
57180	E11		17		11			
57181	E12		18		60			
57182	E14		20					
57183	E16		21		75			
57184	E18		24					
57185	E20		14		80			
57186	E22				26	23		
57187	E24				28	25		

DIN 3120





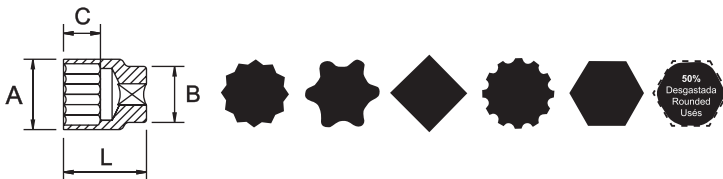

CARACTERÍSTICAS / FEATURES / CARACTÉRISTIQUES

Cr-V



■ SPLINE



COD.					L (mm)	A (mm)	B (mm)	C (mm)			
55795	M12	10	-	-	38	15,5	22	14	47	25	●
55811	-	-	3/8	-		17					
55796	M14	11	7/16	E14		18					
55797	M15	12	-	E16		19					
55798	M16	13	1/2	-		21					
55799	M18	14	-	E18		65					
55800	-	15	-	-							
55801	M20	16	5/8	E20		60					
55802	-	17	-	-		75					
55803	y M22	18	-	E22		80					
55804	M24	19	3/4	E24	60						
55805	M25	20	-	-	24						
55806	M26	21	13/16	-	26						
55807	M28	22	7/8	-	17						
55808	M30	24	15/16	-	32						
55833	-	-	1	-	40	34	28	19	115	10	
55809	M34	27	1.1/16	-	42	36	32	20	140	8	
55834	-	-	1.1/8	-	43	38	32	20	155	8	
55810	M38	30	1.3/16	-	44	40	35	22	180		

DIN 3120

CARACTERÍSTICAS / FEATURES / CARACTÉRISTIQUES

Cr-V



*Para tornillos TORX® (Marca registrada por Acument Intellectual Properties, LLC, Troy, Mich., US) / *For screws TORX® (Acutment Intellectual Properties, LLC, Troy, Mich., US registered trademark) / **Pour vis TORX® (Marque enregistrée par Acument Intellectual Properties, LLC, Troy, Mich., US)

y 100% cromado pulido espejo / 100% mirror polished chrome plating / 100% polie chromée

Si no encuentra el artículo que necesita, consúltenos en info@egamaster.com o en www.egamaster.com
 If you can't find the item you look for, please ask us in info@egamaster.com or in www.egamaster.com
 Si vous ne trouvez pas l'article que vous desirez, consultez-nous a info@egamaster.com ou a www.egamaster.com

1/2"

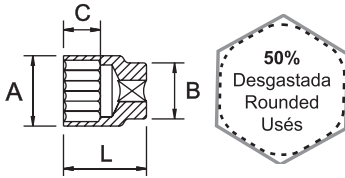
EXTRACTOR DE TUERCAS DESGASTADAS HASTA EL 50% / SCREW EXTRACTOR FOR 50% ROUNDED OFF NUTS / EXTRACTEUR D'ÉCROUS USÉS JUSQU'À 50% / AUSZIEHER 50% ABGENUTZTE MUTTER / ESTRATTORE PER DADI SPANATI FINO AL 50% / EXTRACTOR DE PORCAS DESGASTADAS ATÉ 50% / СЪЁМНИК ДЛЯ СВЕРНУТЫХ НА 50% ГАЕЕК

COD.	AF mm	L (mm)	A (mm)	B (mm)	C (mm)	g		
55795	10		15,5			47		
55796	11		17			48		
55797	12		18					
55798	13		19				25	
55799	14		21	22	14	50		
55800	15							
55801	16	38	24			65		
55802	17					60		
55803	18	y				75	20	•
55804	19		26	23		60		
55805	20		28	24		80		
55806	21		30	26	17	70	15	
55807	22					85		
55808	24		32	28		95	10	
55809	27	42	36	32	20	140		
55810	30	44	40	35	22	180	8	



DIN 3120

CARACTERÍSTICAS / FEATURES / CARACTÉRISTIQUES

Cr-V

PUNTAS ATORNILLADORAS CON VASO / SOCKET BITS / EMBOUTS DE VISSAGE AVEC DOUILLE / STECKSCHLÜSSELEINSATZ / INSERTI A BUSSOLA / PONTAS APARAFUSADORAS COM CAIXA / ГОЛОВКИ-БИТЫ
PLANA / FLAT / À FENTE / FLACH / PIATTA / PLANA / ПЛОСКАЯ

COD.	mm	L (mm)	g		
66801	1,2 x 8				
66802	1,6 x 10	62	75	10	•
66803	2 x 12				

PHILIPS





COD.		L (mm)	g		
66804	PH-2				
66805	PH-3	56	70	10	•
66806	PH-4				



1/2"





■ HEXAGONAL / HEXAGONAL / HEXAGONALE / HEXAGONAL / ESAGONALE / HEXAGONAL / ШЕСТИГРАННАЯ

■ MM

COD.		L (mm)			
66807	4				
66808	5				
55704	5,5				
66809	6				
66810	7				
66811	8		75		
67213	9				
55705	9,5	55		10	●
66812	10				
67214	11				
66813	12		80		
55706	13		95		
66814	14				
55708	17				
55707	19		150		







■ INCH

COD.		L (mm)			
55688	7/32				
55689	1/4				
55690	5/16		75		
55691	3/8				
55692	7/16	55	80	10	●
55693	1/2		95		
55695	5/8		115		
55696	3/4		120		







■ HEXAGONAL SERIE LARGA / HEXAGONAL LONG / HEXAGONALE SÉRIE LONGUE / HEXAGONAL LANG / ESAGONALE SERIE LUNGO / HEXAGONAL SÉRIE LONGA / ШЕСТИГРАННАЯ ВЫСОКАЯ

■ MM

COD.		L (mm)			
66815	5				
66816	6				
66817	7				
66818	8	100	75	10	●
66819	10				
66842	14				







■ INCH

COD.		L (mm)			
56985	7/32		90		
56986	1/4				
56987	5/16		95		
56988	3/8		100		
56989	7/16	100	110	10	●
56990	1/2		115		
56991	9/16		170		
56992	5/8		235		
56993	3/4		350		







1/2"

■ XZN

COD.		L (mm)			
66820	M-5	55	75	10	●
66821	M-6				
66822	M-8				
66823	M-10				
66824	M-12				
66825	M-14				
56896	M-16	140			







■ XZN SERIE LARGA / XZN LONG / XZN SÉRIE LONGUE / XZN LANG / XZN SERIE LUNGO / XZN SÉRIE LONGA / XZN ДЛИННАЯ

COD.		L (mm)			
66826	M-6	100	100	10	●
66827	M-8		120		
66828	M-10		160		
66829	M-12		165		
56897	M-14		165		







■ TORX®

COD.		L (mm)			
66830	T-20	55	80	10	●
66831	T-25				
66832	T-27				
66833	T-30				
66834	T-40				
66835	T-45				
66836	T-50				
66837	T-55				
56895	T-60				







■ TORX® SERIE LARGA / TORX® LONG / TORX® SÉRIE LONGUE / TORX® LANG / TORX® SERIE LUNGO / TORX® SÉRIE LONGA / TORX® ДЛИННАЯ

COD.		L (mm)			
66838	T-40	100	100	10	●
66839	T-45		110		
66840	T-50				
66841	T-55				



■ PUNTA RIBE® CON VASO / RIBE® BIT SOCKETS / POINTE RIBE® AVEC DOUILLE / RIBE® SOCKETBIT / CHIAVI A BUSSOLA PUNTA RIBE® / PONTEIRA RIBE® COM CHAVE DE CAIXA / ГОЛОВКА ТОРЦЕВАЯ СО ВСТАВКОЙ С ПРОФИЛЕМ RIBE®

COD.		L (mm)			
65985	M5	100	90	10	●
65986	M6				
65987	M7				
65988	M8				
65989	M9				
65990	M10				
65991	M12				
65992	M14				
65993	M16				



• *Para tornillos TORX® (Marca registrada por Acument Intellectual Properties, LLC, Troy, Mich., US) / *For screws TORX® (Acument Intellectual Properties, LLC, Troy, Mich., US registered trademark) / *Pour vis TORX® (Marque enregistrée par Acument Intellectual Properties, LLC, Troy, Mich., US)

• *Para tornillos RIBE® (Marca registrada por Richard Bergner Verbindungstechnik GmbH & Co. KG) / *For screws RIBE® (Richard Bergner Verbindungstechnik GmbH & Co. KG registered trademark) / *Pour vis RIBE® (Marque enregistrée par Richard Bergner Verbindungstechnik GmbH & Co. KG)

1/2"

SET

COD.	AF inch	PCS.	g		COD. PCS.	Composición / Composition / Composition
55993	1/2	900	1	1	66801, 66802, 66803, 66804, 66805, 66806, 66807, 66808, 66809, 66811, 66812, 66813	1,2 x 8 - 6 x 10 - 2 x 12 mm - PH-2, PH-3, PH-4 - HEX-4 - HEX-5 - HEX-6 - HEX-8 - HEX-10 - HEX-12
55994		1000			66807, 66808, 55704, 66809, 66810, 66811, 55705, 66812, 66813, 55706, 66814, 55707	HEX-4 - HEX-5 - HEX-5,5 - HEX-6 - HEX-7 - HEX-8 - HEX- 9,5 - HEX-10 - HEX-12 - HEX-13 - HEX-14 - HEX-19
55998		750			55688, 55689, 55690, 55691, 55692, 55693, 55695, 55696	HEX-7/32" - HEX-1/4" - HEX-5/16" - HEX-3/8" - HEX 7/16" - HEX-1/2" - HEX-5/8" - HEX-3/4" - HEX-14 mm
55995		650			66830, 66831, 66832, 66833, 66834, 66835, 66836, 66837	T-20 - T-25 - T-27 - T-30 - T-40 - T-45 - T-50 - T-55



ADAPTADOR / ADAPTER / ADAPTATEUR / VERBINDUNGSTEIL / ADATTATORE / REDUTOR / АДАПТЕР

COD.	AF inch	AF inch	g		
65885	1/2-3/8		50	6	•
65882	1/2-3/4		125		



1/2"

LLAVE FIJA CROW FOOT / OPEN END CROW FOOT WRENCH / CLÉ À FOURCHE CROW FOOT / EINSTECK-MAULSCHLÜSSEL / CHIAVE FISSA CROW FOOT / PONTEIRA DE BOCA COM QUADRADO INTERIOR / РОЖКОВЫЙ КЛЮЧ С КВАДРАТОМ

■ MM

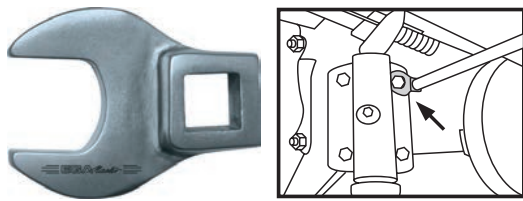
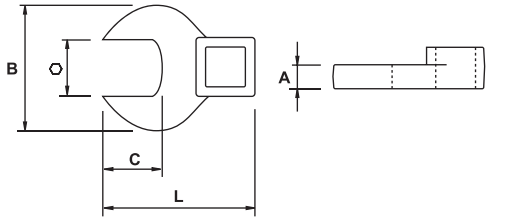

■ INCH

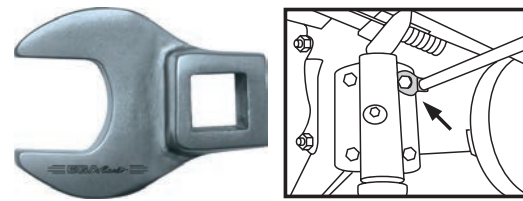
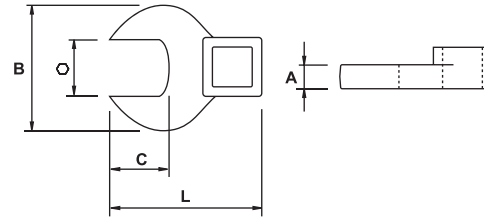

COD.	AF mm	L (mm)	A (mm)	B (mm)	C (mm)	g		
57224	20	50	12	42	19	150		
57225	21			43	20			
57226	22	55	12	45	21	160		
57227	23			46	22			
57228	24	60	12	47	23	185		
57229	25			49	24			
57230	26	65	12	50	25	190		
57231	27			55	26			
57232	28	70	12	55	27	200		
57233	29			60	28			
57234	30	75	12	60	29	220		
57235	31			65	30			
57236	32	80	12	65	31	250	10	●
57237	33			70	32			
57238	34	85	12	75	33	260		
57239	35			80	34			
57240	36	90	12	80	35	270		
57241	37			85	36			
57242	38	95	12	85	37	290		
57243	39			90	38			
57244	40		14	80	39	300		
57245	41			85	40			
57246	42		14	90	41	320		
57247	43			95	42			
57248	44		15	95	43	360		
57249	45			100	44			
57250	46			100	44	380		

COD.	AF inch	L (mm)	A (mm)	B (mm)	C (mm)	g		
57251	15/16	55	12	45	21	160		
57252	1	60		47	23			
57253	1.1/16	60	14	50	25	190		
57254	1.1/8	65		60	26			
57255	1.3/16	70	14	60	28	210		
57256	1.1/4	70		70	30			
57257	1.5/16	75	15	65	31	250		
57258	1.3/8	75		70	33			
57259	1.7/16	80	15	70	34	270		
57260	1.1/2	80		75	36			
57261	1.9/16	85	15	80	37	290		
57262	1.5/8	85		80	39			
57263	1.11/16	90	15	84	41	330	10	●
57264	1.3/4	90		84	42			
57265	1.13/16	95	15	88	44	380		
57266	1.7/8	95		90	45			
57267	1.15/16	100	15	95	46	430		
57268	2	100		95	49			
57269	2.1/16	105	15	100	49	480		
57270	2.1/8	105		100	50			
57271	2.3/16	110	15	105	55	700		
57272	2.1/4	110		105	55			
57273	2.5/16	110	15	110	60	750		
57274	2.3/8	110		110	60			
57275	2.7/16	110	15	110	60	850		
57276	2.1/2	110		110	60			

LLAVES DE VASO PARA BUJÍAS / SPARK PLUG SOCKETS / DOUILLES POUR BOUGIES / ZÜNDKERZEN - STECKSCHLÜSSEL / CHIAVI PER CANDELE / CHAVES DE CAIXA PA VELAS / ГОЛОВКИ ДЛЯ СВЕЧЕЙ ЗАЖИГАНИЯ

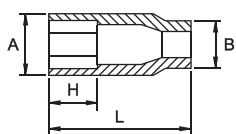

COD.	AF inch	AF mm	L (mm)	A (mm)	B (mm)	H (mm)	g		
61462	1/2	16	65	22	22	14	100	6	●
61463	1/2	21		28	24	16			



1/2"

MANGO ARTICULADO / SWIVEL HANDLE / MANCHE ARTICULÉ / GELENKGRIF / IMPUGNATURA SNODABILE / CABO ARTICULADO / РУЧКА С ШАРНИРОМ

COD.	AF inch	L (mm)	∠	g
61441	1/2	390	0 - 180°	650

MANGO ARTICULADO DE ACCIÓN RÁPIDA / QUICK RELEASE SWIVEL HANDLE / MANCHE ARTICULÉ ACTION RAPIDE / GELENKGRIF MIT SCHNELLVERSTELLUNG / MANICO SNODABILE AZIONE RAPIDA / CABO ARTICULADO DE AÇÃO RÁPIDA / БЫСТРОСЪЕМНАЯ РУЧКА С ШАРНИРОМ

COD.	AF inch	L (mm)	g	📦
61483	1/2	430	900	5

MANGO ARTICULADO TELESCÓPICO / TELESCOPIC SWIVEL HANDLE / MANCHE ARTICULÉ TÉLESCOPIQUE / TELESKOPISCHE GELENKGRIF / MANICO SNODABILE FLESSIBILE / CABO ARTICULADO TELESCÓPICO / ТЕЛЕСКОПИЧЕСКАЯ РУЧКА С ШАРНИРОМ

COD.	AF inch	L min. (mm)	L max. (mm)	g	📦
61484	1/2	430	650	1150	5

ALARGADERA / EXTENSION / RALLONGE / VERLÄNGERUNG / PROLUNGA / EXTENÇÃO / УДЛИНИТЕЛЬ

COD.	AF inch	L (inch)	g	📦	📋
61453	1/2	3	135	5	•
61455		5	220		
61458		10	370		
61464		15	590		
61472		20	740		



DIN 3123

ALARGADERA FLEXIBLE / FLEXIBLE HANDLE / RALLONGE FLEXIBLE / GELENK-STECKGRIF / PROLUNGA FLESSIBILE / EXTENSÃO FLEXÍVEL / ГИБКИЙ УДЛИНИТЕЛЬ

N!

COD.	AF inch	L (inch)	g	📦
62119	1/2	8	300	5

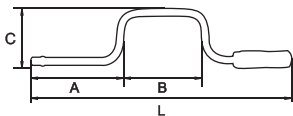

DIN 3122

BERBIQUÍ / SPEEDER HANDLE / VILEBREQUIN / KURBEL / LEVA GIROBECCHINO / MANIVELA / КОЛЕНЧАТАЯ РУЧКА

COD.	AF inch	L (mm)	A (mm)	B (mm)	C (mm)	g	📦
61434	1/2	410	130	145	95	550	5



DIN 3122

LLAVE DE CARRACA REVERSIBLE / REVERSIBLE RATCHET HANDLE / CLÉ À CLIQUET RÉVERSIBLE / UMSCHALTKNARRE / CHIAVE A CRICCO REVERSIBILE / ROQUETE REVERSIVEL / РЕВЕРСИВНАЯ ТРЕЩЕТКА



COD.	AF inch	L (mm)	A (mm)	B (mm)	C (mm)	g	📦	📋
61430	1/2	230	39	31	45	550	6	•

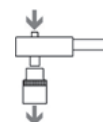

DIN 3122

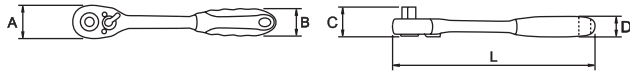

1/2"



COD.	AF inch	L (mm)	A (mm)	B (mm)	C (mm)	D (mm)	g	Icon 1	Icon 2
62606	1/2	250	42	36	37	28	560	6	●

DIN 3122

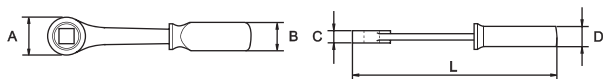
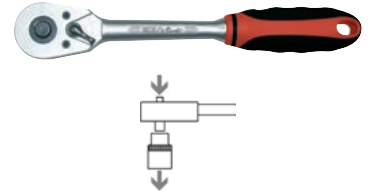

COD.	AF inch	L (mm)	A (mm)	B (mm)	C (mm)	D (mm)	g	Icon 1	Icon 2
61168	1/2	280	45	40	25	25	540	6	●

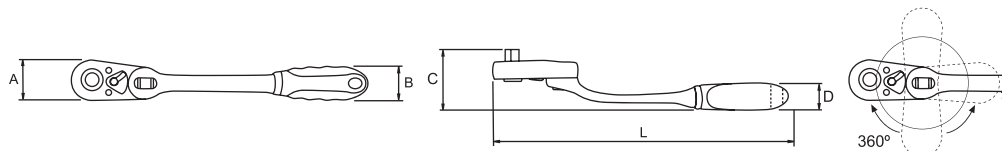

COD.	AF inch	L (mm)	A (mm)	B (mm)	C (mm)	D (mm)	g	Icon 1	Icon 2
57410	1/2	310	40	36	72	28	750	6	●

DIN 3122

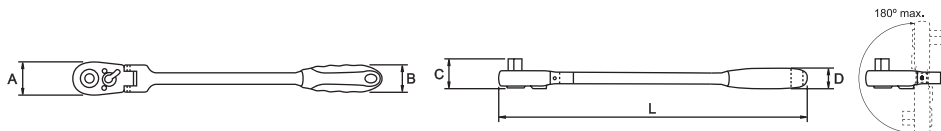

COD.	AF inch	L (mm)	A (mm)	B (mm)	C (mm)	D (mm)	g	Icon 1	Icon 2
57413	1/2	450	37	36	38	28	880	6	●

DIN 3122

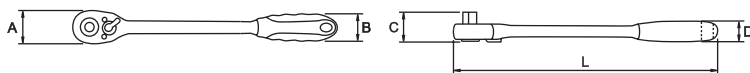

COD.	AF inch	L (mm)	A (mm)	B (mm)	C (mm)	D (mm)	g	Icon 1	Icon 2
57416	1/2	380	42	36	38	28	710	6	●

DIN 3122



■ **MANGO CORREDIZO EN "T" / SLIDING "T" HANDLE / POIGNÉE COULISSANTE / QUERGRIF / ASTA CON QUADRO SCORREVOLO / CABO "T" CORREDIÇO / ПОДВИЖНАЯ "Т" РУЧКА**

COD.	AF inch	L (mm)	g	Icon 1	Icon 2
61440	1/2	250	160	5	●

DIN 3122



■ **ARTICULACIÓN UNIVERSAL / UNIVERSAL JOINT / CARDAN UNIVERSEL / KARDANGELNENK / SNODO CARDANICO / CARDAN UNIVERSAL / ШАРНИР**

COD.	AF inch	g	Icon 1	Icon 2
61437	1/2	140	10	●

DIN 3123



■ 3/4"
■ STANDARD
■ MM

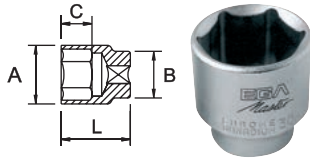

■ INCH

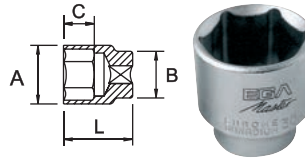

COD.	AP ^{mm}	L (mm)	A (mm)	B (mm)	C (mm)	Pt	g	Icon 1	Icon 2
60501	19		30	33					
60502	21		32		14	210			
60503	22		33		15				
60504	23		34		16				
60505	24	50	34	36	17	220			
60506	25		36		17				
60507	26		36						
60508	27		38						
60509	28		39		24	230	10		
60510	29		40			250			
60511	30		42			290			
60512	32		44	38	26	300			
60513	33	x	46		28	330			
60514	34	55	46		26	6			
60515	35		48	42	28	390			
60516	36		50		29	420			
60517	38		50	43	31	470			
60518	40	60				500			
60519	41	65	55	45	34	550			
60520	42								
60521	46	70	60		37	650			
60522	50		70		38	850	5		
60525	54	75	75	48	40	1000			
60523	55				41				
60524	60	80	80			1100			
60546	65	82	82		45	1350			

● I DIN 3124

CARACTERÍSTICAS / FEATURES / CARACTÉRISTIQUES

Cr-V

COD.	AP ^{inch}	L (mm)	A (mm)	B (mm)	C (mm)	Pt	g	Icon 1	Icon 2
67595	7/8		33			210			
67596	15/16		35	36	17	220			
67597	1	50	38		24	270			
67598	1.1/16		40	38	27	290	10		
67599	1.1/8		44	42	28	310			
67601	1.1/4	55	46	39	29	350			
67602	1.5/16		48		30	400			
67603	1.3/8		50	45	32	460			
67604	1.7/16	60	55	45	32	550			
67605	1.1/2		60		34	700	5		
67607	1.5/8		65	60	34	700			
67608	1.11/16		70	70	48	850			
67610	1.13/16		70	70	48	850			
67612	2	70	70	48	41	850			

● I DIN 3124

CARACTERÍSTICAS / FEATURES / CARACTÉRISTIQUES

Cr-V

x 50% cromado aeroespacial - 50% cromado pulido espejo / 50% aerospace chrome plating - 50% mirror polished chrome plating / 50% chromée aérospatiale - 50% polie chromée
y 100% cromado pulido espejo / 100% mirror polished chrome plating / 100% polie chromée

3/4"

MM

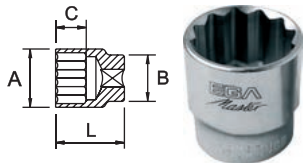

COD.	AF mm	L (mm)	A (mm)	B (mm)	C (mm)	Pt	g	Icons
67565	19		30	33				
67566	21		32		14		210	
67567	22							
67568	23		33		15			
67569	24	50	34	36				
67570	25		36		17		220	
67571	26							
67572	27		38					
67573	29		40		24		250	10
67574	30		42				290	
67575	32		44	38	26		300	
67576	33				28			
67577	34	55	46		26	12	330	
67578	35		48		28		390	
67579	36		50	42	29		420	
67580	38			43	31		470	
67581	40	60					500	
67582	41		55					
67583	42	65	45	34			550	
67584	44		60		37		600	5
67585	46	70					650	
67586	50		70	48	38		850	
67587	54	75	75		40		1000	
67588	55							

DIN 3124

CARACTERÍSTICAS / FEATURES / CARACTÉRISTIQUES

Cr-V

INCH

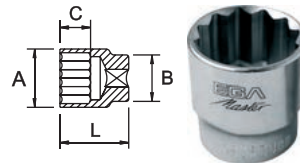

COD.	AF inch	L (mm)	A (mm)	B (mm)	C (mm)	Pt	g	Icons
60526	3/4		30					
60527	7/8		33				210	
60528	15/16			36	17			
60529	1	50	35				220	
60530	1.1/16		38		24			
60531	1.1/8		40		27			
60500	1.3/16		42	38	25		270	10
60532	1.1/4		44		28		290	
60533	1.5/16	55	46	39	29	12	310	
60534	1.3/8		48		42		350	
60535	1.7/16	60	50		30		400	
60536	1.1/2						460	
60537	1.5/8		55		32			
60538	1.11/16			45	34		550	
60499	1.3/4	65	60		35			5
60539	1.13/16			47			700	
60540	1.7/8	70	65	48	39			
60541	2		70		41		850	

DIN 3124

CARACTERÍSTICAS / FEATURES / CARACTÉRISTIQUES

Cr-V

x 50% cromado aeroespacial - 50% cromado pulido espejo / 50% aerospace chrome plating - 50% mirror polished chrome plating / 50% chromée aérospatiale - 50% polie chromée
y 100% cromado pulido espejo / 100% mirror polished chrome plating / 100% polie chromée

3/4"

SERIE LARGA / LONG SOCKETS / SÉRIE LONGUE / LANGE SERIE / SERIE LUNGA / SERIE LONGA / ВЫСОКАЯ СЕРИЯ

■ MM

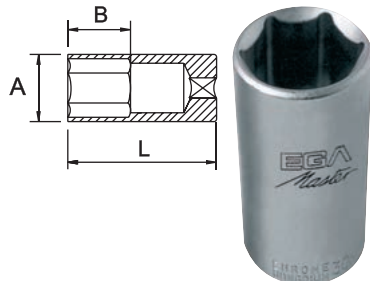

■ INCH

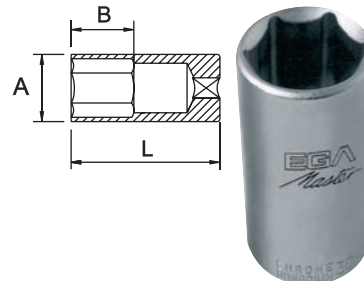

COD.	AF mm	L (mm)	A (mm)	B (mm)	Pt	g		
56900	19		29			300		
56901	21		31			320		
56902	22		32	26		360		
56903	23		33			380		
56904	24		34			400	10	
56905	26		37					
56906	27					420		
56899	x 28	90	38		6			•
56907	29		40	28		460		
56908	30		42			510		
56909	32		44			560		
56910	34		47			610		
56911	36		50	30		670	5	
56912	38		52	34		700		
56913	41		56			790		

COD.	AF inch	L (mm)	A (mm)	B (mm)	Pt	g		
56914	3/4		29			300		
56915	7/8		32	26		360		
56916	15/16		34			400	10	
56917	1		37			410		
56918	y 1.1/16	90	38		6	420		•
56919	1.1/8		40	28		460		
56920	1.1/4		44			560		
56921	1.3/8		48	30		640	5	
56922	1.1/2		52	34		700		
56923	1.5/8		56			790		

○ I DIN 3124

CARACTERÍSTICAS / FEATURES / CARACTÉRISTIQUES

Cr-V

○ I DIN 3124

CARACTERÍSTICAS / FEATURES / CARACTÉRISTIQUES

Cr-V

ADAPTADOR / ADAPTER / ADAPTATEUR / VERBINDUNGSTEIL / ADATTATORE / REDUTOR / АДАПТЕР

COD.	AF inch	AF inch	g		
65883	3/4-1		250		6
65886	3/4-1/2"		135		•



LLAVE DE CARRACA REVERSIBLE / REVERSIBLE RATCHET HANDLE / CLÉ À CLIQUET RÉVERSIBLE / UMSCHALTKNARRE / CHIAVE A CRICCO REVERSIBILE / ROQUETE REVERSIVEL / РЕВЕРСИВНАЯ ТРЕЩЕТКА

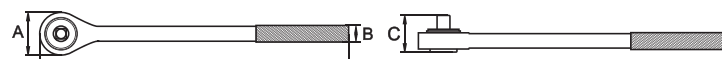

COD.	AF inch	L (mm)	A (mm)	B (mm)	C (mm)	Kg
61859	3/4	500	69	25	58	2,2

DIN 3122



MANGO ARTICULADO / SWIVEL HANDLE / MANCHE ARTICULÉ / GELENKGRIF / IMPUGNATURA SNODABILE / CABO ARTICULADO / РУЧКА С ШАРНИРОМ

COD.	AF inch	L (mm)	Kg	
61473	3/4	1000	3,7	6



x 50% cromado aeroespacial - 50% cromado pulido espejo / 50% aerospace chrome plating - 50% mirror polished chrome plating / 50% chromée aérospatiale - 50% polie chromée
y 100% cromado pulido espejo / 100% mirror polished chrome plating / 100% polie chromée

3/4"

COD.	AF inch	L (mm)	Kg	
61456	3/4	480	1,9	6



■ MANGO CORREDIZO EN "T" / SLIDING "T" HANDLE / POIGNÉE COULISSANTE / QUERGRIF / ASTA CON QUADRO SCORREVOLO / CABO "T" CORREDIÇO / ПОДВИЖНАЯ "Т" РУЧКА

COD.	AF inch	L (mm)	g	
61864	3/4	450	1200	5

DIN 3122



■ ARTICULACIÓN UNIVERSAL / UNIVERSAL JOINT / CARDAN UNIVERSEL / KARDANGELNENK / SNODO CARDANICO / CARDAN UNIVERSAL / ШАРНИР

COD.	AF inch	g		
61860	3/4	600	6	•

DIN 3123



■ ALARGADERA / EXTENSION / RALLONGE / VERLÄNGERUNG / PROLUNGA / EXTENÇÃO / УДЛИНИТЕЛЬ

COD.	AF inch	L (inch)	g		
61865	3/4	4	410	5	•
63910		5	480		
61866		8	700		
63911		12	1050		
63912		16	1300		
63913		20	1650		

DIN 3123



EGGA *Master*
ART IN INNOVATION

- 1"
- STANDARD
- MM

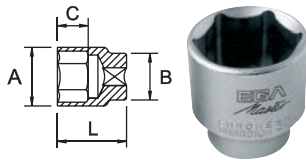

- INCH

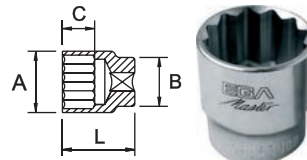

COD.	AF mm	L (mm)	A (mm)	B (mm)	C (mm)	Pt	g	Icons
65001	36	65	50		32		500	
65002	41	70	55	45	35		600	
65003	46	75	65	50	39		850	
65004	50	80	70		41		1050	5
65005	54		75				1150	
65006	55	80			42		1250	
65007	58						1300	
65008	60		80	55			1400	
65009	63	85	85		47	6	1500	
65010	65		90				1550	
65011	67	90			50		1650	
65012	70		95				2050	4
65013	71	95	100	70			2400	
65014	75		100				2400	
65015	77	105	105		60		2550	
65016	80							

● DIN 3124

CARACTERÍSTICAS / FEATURES / CARACTÉRISTIQUES
Cr-V

COD.	AF inch	L (mm)	A (mm)	B (mm)	C (mm)	Pt	g	Icons
65022	1.5/8	70	55	45	35		550	
65023	1.13/16		65	50			800	
65024	1.7/8	75			37		950	
65025	2		70				1000	5
65026	2.1/8		75		38		1100	
65027	2.3/16	80		55			1150	
65028	2.1/4		80		43	12	1200	
65029	2.3/8		85		45		1300	
65030	2.1/2	85	85		48		1400	
65031	2.5/8	90	90		50		1550	
65032	2.3/4	95	95		55		1950	4
65033	3		105	70	60		2450	
65034	3.1/8	105	105					

● DIN 3124

CARACTERÍSTICAS / FEATURES / CARACTÉRISTIQUES
Cr-V

■ **ADAPTADOR / ADAPTER / ADAPTATEUR / VERBINDUNGSTEIL / ADATTATORE / REDUTOR / АДАПТЕР**

COD.	AF inch	AF inch	g	Icons
65040	1-3/4		430	6



■ **MANGO ARTICULADO / SWIVEL HANDLE / MANCHE ARTICULÉ / GELENKGRIF / IMPUGNATURA SNODABILE / CABO ARTICULADO / РУЧКА С ШАРНИРОМ**

COD.	AF inch	L (mm)	Kg	Icons
61474	1	1000	4,0	6



COD.	AF inch	L (mm)	Kg	Icons
61457	1	650	2,5	6



■ **LLAVE DE CARRACA REVERSIBLE / REVERSIBLE RATCHET HANDLE / CLÉ À CLIQUET RÉVERSIBLE / UMSCHALTKNARRE / CHIAVE A CRICCO REVERSIBILE / ROQUETE REVERSIVEL / РЕВЕРСИВНАЯ ТРЕЩЕТКА**

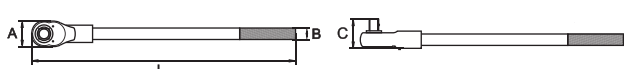

COD.	AF inch	L (mm)	A (mm)	B (mm)	C (mm)	Kg	Icons
65035	1	650	71	29	67	4,4	1



x 50% cromado aeroespacial - 50% cromado pulido espejo / 50% aerospaceal chrome plating - 50% mirror polished chrome plating / 50% chromée aérospatiale - 50% polie chromée

09

LLAVES DE VASO
SOCKET WRENCHES
DOUILLES
STECKSCHLÜSSEL
BUSSOLE
CHAVES DE CAIXA
ГОЛОВКИ



1"

■ MANGO CORREDIZO EN "T" / SLIDING "T" HANDLE / POIGNÉE COULISSANTE / QUERGRIF / ASTA CON QUADRO SCORREVOLO / CABO "T" CORREDIÇO / ПОДВИЖНАЯ "Т" РУЧКА

COD.	AF inch	L (mm)	g	
65036	1	550	3300	1

DIN 3122



■ ARTICULACIÓN UNIVERSAL / UNIVERSAL JOINT / CARDAN UNIVERSEL / KARDANGELNENK / SNODO CARDANICO / CARDAN UNIVERSAL / ШАРНИР

COD.	AF inch	g		
65039	1	1200	4	•

DIN 3123



■ ALARGADERA / EXTENSION / RALLONGE / VERLÄNGERUNG / PROLUNGA / EXTENÇÃO / УДЛИНИТЕЛЬ

COD.	AF inch	L (mm)	L (inch)	g	
65037	1	200	8	1150	5
65038		400	16	2300	

DIN 3123



■ KITS - SETS

■ 1/4"

■ 10 PCS.

COD.	AF inch	PCS.		Kg
58694	1/4	10	SERIE ESTÁNDAR / STANDARD PATTERN / SÉRIE STANDARD	0,7

PCS./UN.	Composición / Composition / Composition	Descripción / Description / Description		
6	57165, 57166, 57167, 57168, 57169, 57170	Llaves de vaso TORX / TORX Socket wrenches	E4-E5-E6-E7-E8-E10	★ -
	62603	Carraca / Ratchet	-	
	61443	Alargadera / Extension	6"	
1	61435	Articulación universal / Universal joint	-	
	61438	Mango en T / T handle	-	



■ 12 PCS.

COD.	AF inch	PCS.		Kg
58685	1/4	12	SERIE ESTÁNDAR / STANDARD PATTERN / SÉRIE STANDARD	0,7

PCS./UN.	Composición / Composition / Composition	Descripción / Description / Description		
9	61311, 61312, 61313, 61314, 61315, 61316, 61317, 61318, 61319	Llaves de vaso / Socket wrenches	4-5-6-7-8-9-10-11-12 mm	○ -
1	62603	Carraca / Ratchet	-	
2	61442, 61443	Alargadera / Extension	2" - 4"	

COD.	AF inch	PCS.		Kg
58687	1/4	12	SERIE LARGA / LONG PATTERN / SÉRIE LONGUE	0,9

PCS./UN.	Composición / Composition / Composition	Descripción / Description / Description		
9	67640, 67642, 67644, 67645, 67646, 67647, 67648, 67649, 67650	Llaves de vaso serie larga / Long socket wrenches	4-5-6-7-8-9-10-11-12 mm	○ -
1	62603	Carraca / Ratchet	-	
2	61442, 61443	Alargadera / Extension	2" - 4"	



09

LLAVES DE VASO
SOCKET WRENCHES
DOUILLES
STECKSCHLÜSSEL
BUSSOLE
CHAVES DE CAIXA
ГОЛОВКИ



1/4"

N!

COD.	AF inch	PCS.		Kg
58686	1/4	12	SERIE ESTÁNDAR / STANDARD PATTERN / SÉRIE STANDARD	0,7

PCS./UN.	Composición / Composition / Composition	Descripción / Description / Description		
9	60421, 60422, 60423, 60424, 60425, 60426, 60427, 60428, 60429	Llaves de vaso / Socket wrenches	3/16" - 7/32" - 1/4" - 9/32" - 5/16" - 11/32" - 3/8" - 7/16" - 1/2"	
1	62603	Carraca / Ratchet	-	
2	61442, 61443	Alargadera / Extension	2" - 4"	



N!

COD.	AF inch	PCS.		Kg
58688	1/4	12	SERIE LARGA / LONG PATTERN / SÉRIE LONGUE	0,9

PCS./UN.	Composición / Composition / Composition	Descripción / Description / Description		
9	67675, 67676, 67677, 67678, 67679, 67680, 67681, 67682, 67683	Llaves de vaso / Socket wrenches	3/16" - 7/32" - 1/4" - 9/32" - 5/16" - 11/32" - 3/8" - 7/16" - 1/2"	
1	62603	Carraca / Ratchet	-	
2	61442, 61443	Alargadera / Extension	2" - 4"	

COD.	AF inch	PCS.		Kg
61323	1/4	12	SERIE ESTÁNDAR / STANDARD PATTERN / SÉRIE STANDARD	0,4

PCS./UN.	Composición / Composition / Composition	Descripción / Description / Description		
11	61311, 61312, 61313, 61314, 61315, 61316, 61317, 61318, 61319, 61320, 61321	Llaves de vaso / Socket wrenches	4-5-6-7-8-9-10-11-12-13-14 mm	
1	62603	Carraca / Ratchet	-	



COD.	AF inch	PCS.		Kg
61324	1/4	12	SERIE ESTÁNDAR / LONG PATTERN / SÉRIE STANDARD	0,4

PCS./UN.	Composición / Composition / Composition	Descripción / Description / Description		
11	60420, 60421, 60422, 60423, 60424, 60425, 60426, 60427, 60428, 60429, 60430	Llaves de vaso / Socket wrenches	5/32" - 3/16" - 7/32" - 1/4" - 9/32" - 5/16" - 11/32" - 3/8" - 7/16" - 1/2" - 9/16"	
1	62603	Carraca / Ratchet	-	

■ 16 PCS.

N!

COD.	AF inch	PCS.		Kg
58689	1/4	16	SERIE ESTANDAR / STANDARD PATTERN / SÉRIE STANDARD	0,9

PCS./UN.	Composición / Composition / Composition	Descripción / Description / Description		
11	60420, 60421, 60422, 60423, 60424, 60425, 60426, 60427, 60428, 60429, 60430	Llaves de vaso / Socket wrenches	5/32" - 3/16" - 7/32" - 1/4" - 9/32" - 5/16" - 11/32" - 3/8" - 7/16" - 1/2" - 9/16"	
	62603	Carraca / Ratchet	-	
	61443	Alargadera / Extension	4"	
1	61435	Articulación universal / Universal joint	-	
	61438	Mango articulado / Hinged handle	-	
	66732	Destornillador portavasos / Socket holder	-	



09

LLAVES DE VASO
SOCKET WRENCHES
DOUILLES
STECKSCHLÜSSEL
BUSSOLE
CHAVES DE CAIXA
ГОЛОВКИ



Management System
ISO 9001:2015
ISO 14001:2015
www.tuc.com
ID 091058048



1/4"

18 PCS.

COD.		PCS.		
55591	1/4	18	SERIE ESTÁNDAR / STANDARD PATTERN / SÉRIE STANDARD	0,9
PCS./UN.	Composición / Composition / Composition	Descripción / Description / Description		
13	61311, 63974, 61312, 63975, 61313, 61314, 61315, 61316, 61317, 61318, 61319, 61320, 61321	Llaves de vaso / Socket wrenches 4-4,5-5-5,5-6-7-8-9-10-11-12-13-14 mm		
	62603	Carraca / Ratchet	-	
	61443	Alargadera / Extension	4"	
	61438	Mango en T / T Handle	-	
1	61435	Articulación universal / Universal joint	-	
	66732	Destornillador portavasos / Socket holder	-	



21 PCS.

N!

COD.		PCS.		
58697	1/4	21	SERIE ESTÁNDAR Y CROWFOOT / STANDARD AND CROWFOOT PATTERN / SÉRIE STANDARD ET CROWFOOT	2,1
PCS./UN.	Composición / Composition / Composition	Descripción / Description / Description		
11	60420, 60421, 60422, 60423, 60424, 60425, 60426, 60427, 60428, 60429, 60430	Llaves de vaso / Socket wrenches 5/32" - 3/16" - 7/32" - 1/4" - 9/32" - 5/16" - 11/32" - 3/8" - 7/16" - 1/2" - 9/16"		
5	57218, 57219, 57220, 57221, 57222	Llaves Fijas Crow Foot / Open end Crow Foot wrench	5/16" - 3/8" - 7/16" - 1/2" - 9/16"	
1	62603	Carraca / Ratchet	-	
2	61454, 61444	Alargadera / Extension	3" - 6"	
1	61435	Articulación universal / Universal joint	-	
	66732	Destornillador portavasos / Socket holder	-	



24 PCS.

N!

COD.		PCS.		
58693	1/4	24	SERIE LARGA / LONG PATTERN / SÉRIE LONGUE	2
PCS./UN.	Composición / Composition / Composition	Descripción / Description / Description		
10	67640, 67642, 67644, 67645, 67646, 67647, 67648, 67649, 67650, 67651	Llaves de vaso serie larga / Long socket wrenches 4-5-6-7-8-9-10-11-12-13 mm		
9	67675, 67676, 67677, 67678, 67679, 67680, 67681, 67682, 67683	Llaves de vaso serie larga / Long socket wrenches 3/16" - 7/32" - 1/4" - 9/32" - 5/16" - 11/32" - 3/8" - 7/16" - 1/2"		
	62603	Carraca / Ratchet	-	
	61442	Alargadera / Extension	2"	
	65874	Mango articulado / Hinged handle	-	
1	61435	Articulación universal / Universal joint	-	
	66732	Destornillador portavasos / Socket holder	-	



09

LLAVES DE VASO
SOCKET WRENCHES
DOUILLES
STECKSCHLÜSSEL
BUSSOLE
CHAVES DE CAIXA
ГОЛОВКИ



Management System
ISO 9001:2015
ISO 14001:2015
www.tuc.com
ID: 091098048



1/4"

COD.		PCS.		
61791	1/4	24	SERIE CORTA / STANDARD PATTERN / SÉRIE STANDARD	1,6
PCS./UN.	Composición / Composition / Composition	Descripción / Description / Description		
10	61311, 61312, 61313, 61314, 61315, 61316, 61317, 61318, 61319, 61320	Llaves de vaso / Socket wrenches	4-5-6-7-8-9-10-11-12-13 mm	
9	60421, 60422, 60423, 60424, 60425, 60426, 60427, 60428, 60429		3/16"-7/32"-1/4"-9/32"-5/16"-11/32"-3/8"-7/16"-1/2"	
	62603	Carraca / Ratchet	-	
	61442	Alargadera / Extension	2"	
1	61435	Articulación universal / Universal joint	-	
	65874	Mango articulado / Hinged handle	-	
	66732	Destornillador portavasos / Socket holder	-	



25 PCS.

COD.		PCS.		
58696	1/4	25	SERIE ESTÁNDAR Y CROWFOOT / STANDARD AND CROWFOOT PATTERN / SÉRIE STANDARD ET CROWFOOT	1,1
PCS./UN.	Composición / Composition / Composition	Descripción / Description / Description		
13	61311, 63974, 61312, 63975, 61313, 61314, 61315, 61316, 61317, 61318, 61319, 61320, 61321	Llaves de vaso / socket wrenches	4-4,5-5-5,5-6-7-8-9-10-11-12-13-14 mm	
7	57211, 57212, 57213, 57214, 57215, 57216, 57217	Llaves fijas Crow Foot / Open end Crow Foot wrenches	7-8-9-10-11-12-13 mm	
1	62603	Carraca / Ratchet	-	
2	61454, 61444	Alargadera / Extension	3"-6"	
1	61435	Articulación universal / Universal joint	-	
	66732	Destornillador portavasos / Socket holder	-	













29 PCS.

COD.		PCS.		
61958	1/4	29	SERIE ESTÁNDAR / STANDARD PATTERN / SÉRIE STANDARD	0,8
PCS./UN.	Composición / Composition / Composition	Descripción / Description / Description		
11	61311, 61312, 61313, 61314, 61315, 61316, 61317, 61318, 61319, 61320, 61321	Llaves de vaso / Socket wrenches	4-5-6-7-8-9-10-11-12-13-14 mm	
1	62603	Carraca / Ratchet	-	
2	61442, 61444	Alargadera / Extension	2"-6"	
	61438	Mango en T / T Handle	-	
1	61435	Articulación universal / Universal joint	-	
5	66743, 66744, 66745, 66746, 66747	Punta hexagonal con vaso / Hex bit socket	3-4-5-6-8	
3	66733, 66734, 66735	Punta plana con vaso / Flat bit socket	4 x 0,8 - 5,5 x 1 - 6,5 x 1,2	
4	66737, 66738, 66739, 58900	Punta Philips con vaso / Philips bit socket	PH1-PH2-PH3-PH4	
1	66732	Destornillador portavasos / Socket holder	-	













1/4"

COD.		PCS.		
61961	1/4	29	SERIE ESTÁNDAR / STANDARD PATTERN / SÉRIE STANDARD	0,8



PCS./UN.	Composición / Composition / Composition	Descripción / Description / Description			
11	60420, 60421, 60422, 60423, 60424, 60425, 60426, 60427, 60428, 60429, 60430	Llaves de vaso / Socket wrenches	5/32"-3/16"-7/32"-1/4"-9/32"-5/16"-11/32"-3/8"-7/16"-1/2"-9/16"		-
1	62603	Carraca / Ratchet	-		
2	61442, 61444	Alargadera / Extension	2"-6"		
	61438	Mango en T / T Handle	-		
1	61435	Articulación universal / Universal joint	-		
5	66743, 66744, 66745, 66746, 66747	Punta hexagonal con vaso / Hex bit socket	3-4-5-6-8		
3	66733, 66734, 66735	Punta plana con vaso / Flat bit socket	4 x 0,8 - 5,5 x 1 - 6,5 x 1,2		
4	66737, 66738, 66739, 58900	Punta Philips con vaso / Philips bit socket	PH1-PH2-PH3-PH4		
1	66732	Destornillador portavasos / Socket holder	-		









COD.		PCS.		
55667	1/4	29	SERIE ESTÁNDAR / STANDARD PATTERN / SÉRIE STANDARD	0,8

PCS./UN.	Composición / Composition / Composition	Descripción / Description / Description			
11	56015, 56017, 56018, 56019, 56020, 56021, 56023, 56024, 56025, 56026, 56027	Spline / SPLINE	M5, M6, M7, M8, M9, M10, M12, M14, M15, M16, M18		-
1	62603	Carraca / Ratchet	-		
2	61442, 61444	Alargadera / Extension	2"-6"		
	61438	Mango en T / T Handle	-		
1	61435	Articulación universal / Universal joint	-		
5		Punta hexagonal con vaso / Hex bit socket	3-4-5-6-8		
3		Punta plana con vaso / Flat bit socket	4 x 0,6 - 5,5 x 1 - 7 x 12		
4		Punta Philips con vaso / Philips bit socket	PH1-PH2-PH3-PH4		
1		Destornillador portavasos / Socket holder	-		



30 PCS.











COD.		PCS.		
58690	1/4	30	SERIE LARGA / LONG PATTERN / SÉRIE LONGUE	3











PCS./UN.	Composición / Composition / Composition	Descripción / Description / Description			
11	67640, 67642, 67643, 67644, 67645, 67646, 67647, 67648, 67649, 67650, 67651 67674, 67675, 67676, 67677, 67678, 67679, 67680, 67681, 67682, 67683, 67684	Llaves de vaso serie larga / Long socket wrenches	4-5-5,5-6-7-8-9-10-11-12-13 mm 5/32"-3/16"-7/32"-1/4"-9/32"-5/16"-11/32"-3/8"-7/16"-1/2"-9/16"		-
1	62603	Carraca / Ratchet	-		
2	61442, 61444	Alargadera / Extension	2"-6"		
	61445	Alargadera flexible	6"		
	61435	Articulación universal / Universal joint	-		
1	65874	Mango articulado / Hinged handle	-		
	61438	Mango en T / T handle	-		
	66732	Destornillador portavasos / socket holder	-		



1/4"

N!











COD.		PCS.		
58691	1/4	30	SERIES ESTÁNDAR Y LARGA	2,8
PCS./UN.	Composición / Composition / Composition	Descripción / Description / Description		
11	60420, 60421, 60422, 60423, 60424, 60425, 60426, 60427, 60428, 60429, 60430	Llaves de vaso / Socket wrenches	5/32"-3/16"-7/32" - 1/4" - 9/32" - 5/16" - 11/32" - 3/8" - 7/16" - 1/2" - 9/16"	
11	67674, 67675, 67676, 67677, 67678, 67679, 67680, 67681, 67682, 67683, 67684	Llaves de vaso serie larga / Long socket wrenches	5/32"-3/16"-7/32" - 1/4" - 9/32" - 5/16" - 11/32" - 3/8" - 7/16" - 1/2" - 9/16"	
1	62603	Carraca / Ratchet	-	
2	61442, 61444	Alargadera / Extension	2" - 6"	
	61445	Alargadera flexible / Flexible extension	6"	
	65874	Mango Articulado / Hinged handle	-	
1	61438	Mango en T / T handle	-	
	61435	Articulación universal / Universal joint	-	
	66732	Destornillador portavasos / Socket holder	-	

COD.		PCS.		
55592	1/4	30	SERIE ESTÁNDAR / STANDARD PATTERN / SÉRIE STANDARD	2,5
PCS./UN.	Composición / Composition / Composition	Descripción / Description / Description		
11	61322, 61311, 61312, 63975, 61313, 61314, 61315, 61316, 61317, 61318, 61319	Llaves de vaso / Socket wrenches	3,2-4-5-5,5-6-7-8-9-10-11-12 mm	
	60420, 60421, 60422, 60423, 60424, 60425, 60426, 60427, 60428, 60429, 60430		5/32"-3/16"-7/32"-1/4"-9/32"-5/16"-11/32"-3/8"-7/16"-1/2"-9/16"	
1	62603	Carraca / Ratchet	-	
2	61442, 61444	Alargadera / Extension	2"-6"	
	61445	Alargadera flexible / Flexible handle	-	
	65874	Mango articulado / Hinged handle	-	
	61438	Mango en T / T Handle	-	
1	61435	Articulación universal / Universal joint	-	
	66732	Destornillador portavasos / Socket holder	-	



■ 32 PCS.

N!

COD.		PCS.		
58695	1/4	32	SERIE ESTÁNDAR / STANDARD PATTERN / SÉRIE STANDARD	1,7
PCS./UN.	Composición / Composition / Composition	Descripción / Description / Description		
1	62603	Carraca / Ratchet	-	
	61443	Alargadera / Extension	4"	
5	66743, 66744, 66745, 66746, 66747	Punta hexagonal con vaso / Hex bit socket	3-4-5-6-8 mm	
4	55697, 55698, 55699, 55700	Punta hexagonal con vaso / Hex bit socket	1/16"-5/64"-9/64"-7/32"	
	66733, 66734, 66735, 66736	Punta plana con vaso / Flat bit socket	4 x 0,8 - 5,5 x 1 - 6,5 x 1,2 - 8 x 1,2	
3	66737, 66738, 66739	Punta Philips con vaso / Philips bit socket	PH1-PH2-PH3	
	66740, 66741, 66742	Punta Pozidriv con vaso / Pozidriv bit socket	PZ1-PZ2-PZ3	
11	66729, 66730, 66748, 66749, 66750, 66751, 6752, 66753, 66754, 66755, 66756	Punta Torx con vaso / Torx bit socket	T6-T7-T8-T9-T10-T15-T20-T25-T27-T30-T40	



09

LLAVES DE VASO
SOCKET WRENCHES
DOUILLES
STECKSCHLÜSSEL
BUSSOLE
CHAVES DE CAIXA
ГОЛОВКИ



1/4"

33 PCS.

COD.	AF ↓ inch ↑	PCS.	Kg
55590	1/4	33	2,8

SERIE ESTÁNDAR Y SERIE LARGA /
 STANDARD AND LONG PATTERN / SÉRIE
 STANDARD ET LONGUE

PCS./UN.	Composición / Composition / Composition	Descripción / Description / Description		
13	61322, 61311, 61312, 63975, 61313, 61314, 61315, 61316, 61317, 61318, 61319, 61320, 61321	Llaves de vaso / Socket wrenches	3,2-4-5-5,5-6-7-8-9-10-11-12-13-14 mm	
12	67640, 67642, 67643, 67644, 67645, 67646, 67647, 67648, 67649, 67650, 67651, 67652	Llaves de vaso serie larga / Long socket wrenches	4-5-5,5-6-7-8-9-10-11-12-13-14 mm	
1	62603	Carraca / Ratchet	-	
2	61442, 61444	Alargadera / Extension	2"-6"	
	61445	Alargadera flexible / Flexible handle		
	65874	Mango articulado / Hinged handle		
	61438	Mango en T / T Handle		
1	61435	Articulación universal / Universal joint	-	
	66732	Destornillador portavasos / Socket holder		



3/8"

10 PCS.

COD.	AF ↓ inch ↑	PCS.	Kg
58700	3/8	10	1

SERIE ESTÁNDAR / STANDARD
 PATTERN / SÉRIE STANDARD

PCS./UN.	Composición / Composition / Composition	Descripción / Description / Description		
8	67620, 67621, 67622, 67623, 67624, 67625, 67626, 67627	Llaves de vaso / Socket wrenches	1/4" - 9/32" - 5/16" - 11/32" - 3/8" - 7/16" - 1/2" - 9/16"	
1	62604	Carraca / Ratchet	-	
	61447	Alargadera / Extension	6"	



12 PCS.

COD.	AF ↓ inch ↑	PCS.	Kg
58706	3/8	12	1,2

SERIE ESTÁNDAR / STANDARD
 PATTERN / SÉRIE LONGUE

PCS./UN.	Composición / Composition / Composition	Descripción / Description / Description		
8	57171, 57172, 57173, 57174, 57175, 57176, 57177, 57178	Llaves de vaso TORX	E8-E10-E11-E12-E14-E16-E18-E20	
	62604	Carraca / Ratchet	-	
	61459	Alargadera / Extension	3"	
1	61436	Articulación universal / Universal joint	-	
	61439	Mango en T / T handle	-	



COD.	AF ↓ inch ↑	PCS.	Kg
58703	3/8	12	1,4

SERIE ESTÁNDAR / STANDARD
 PATTERN / SÉRIE STANDARD

PCS./UN.	Composición / Composition / Composition	Descripción / Description / Description		
8	67620, 67621, 67622, 67623, 67624, 67625, 67626, 67627	Llaves de vaso / Socket wrenches	1/4" - 9/32" - 5/16" - 11/32" - 3/8" - 7/16" - 1/2" - 9/16"	
1	62604	Carraca / Ratchet	-	
2	61447, 61450	Alargadera / Extension	6" - 10"	
1	61439	Mango en T / T handle	-	



09

LLAVES DE VASO
SOCKET WRENCHES
DOUILLES
STECKSCHLÜSSEL
BUSSOLE
CHAVES DE CAIXA
ГОЛОВКИ



3/8"

COD.		PCS.		
55595	3/8	12	SERIE ESTÁNDAR / STANDARD PATTERN / SÉRIE STANDARD	1,2

PCS./UN.	Composición / Composition / Composition	Descripción / Description / Description			
10	67541, 67542, 67543, 67545, 67546, 67547, 67548, 67549, 67552, 67554	Llaves de vaso / Socket wrenches	6-7-8-10-11-12-13-14-17-19 mm		-
1	62604	Carraca / Ratchet	-		
1	61447	Alargadera / Extension	6"		

13 PCS.

COD.		PCS.		
61342	3/8	13	SERIE ESTÁNDAR / STANDARD PATTERN / SÉRIE STANDARD	0,9

PCS./UN.	Composición / Composition / Composition	Descripción / Description / Description	PCS./UN.		
12	60440, 60441, 60442, 60443, 60444, 60445, 60446, 60447, 60448, 60449, 60450, 60451	Llaves de vaso / Socket wrenches	5/16"-11/32"-3/8"-7/16"-1/2"-9/16"-19/32"-5/8"-11/16"-3/4"-13/16"-7/8"		-
1	62604	Carraca / Ratchet	-		



16 PCS.

COD.		PCS.		
58702	3/8	16	SERIE LARGA / LONG PATTERN / SÉRIE LONGUE	2,7

PCS./UN.	Composición / Composition / Composition	Descripción / Description / Description			
11	67751, 67752, 67753, 67754, 67755, 67756, 67757, 67758, 67759, 67760, 67761	Llaves de vaso serie larga / Long socket wrenches	5/16" - 3/8" - 7/16" - 1/2" - 9/16" - 19/32" - 5/8" - 11/16" - 3/4" - 13/16" - 7/8"		-
1	62604	Carraca / Ratchet	-		
2	61447, 61450	Alargadera / Extension	6" - 10"		
1	61436	Articulación universal / Universal joint	-		
1	61439	Mango en T / T handle	-		









COD.		PCS.		
58701	3/8	16	SERIE LARGA / LONG PATTERN / SÉRIE LONGUE	2,7





PCS./UN.	Composición / Composition / Composition	Descripción / Description / Description			
11	67726, 67728, 67729, 67730, 67731, 67732, 67733, 67735, 67737, 67739, 67740	Llaves de vaso serie larga / Long socket wrenches	8-10-11-12-13-14-15-17-19-21-22 mm		-
1	62604	Carraca / Ratchet	-		
2	61447, 61450	Alargadera / Extension	6" - 10"		
1	61436	Articulación universal / Universal joint	-		
1	61439	Mango en T / T handle	-		

3/8"



COD.		PCS.		
61959	3/8	16	SERIE ESTÁNDAR / STANDARD PATTERN / SÉRIE STANDARD	1,9

PCS./UN.	Composición / Composition / Composition	Descripción / Description / Description		
11	61343, 61345, 61346, 61347, 61348, 61349, 61350, 61352, 61354, 61356, 61357	Llaves de vaso / Socket wrenches	8-10-11-12-13-14-15-17-19-21-22 mm	
1	62604	Carraca / Ratchet	-	
2	61447, 61450	Alargadera / Extension	6"-10"	
	61439	Mango en T / T Handle		
1	61436	Articulación universal / Universal joint	-	

COD.		PCS.		
61962	3/8	16	SERIE ESTÁNDAR / STANDAR PATTERN / SÉRIE STANDARD	1,9



PCS./UN.	Composición / Composition / Composition	Descripción / Description / Description		
11	60440, 60442, 60443, 60444, 60445, 60446, 60447, 60448, 60449, 60450, 60451	Llaves de vaso / Socket wrenches	5/16"-3/8"-7/16"-1/2"-9/16"-19/32"-5/8"- 11/16"-3/4"-13/16"-7/8"	
1	62604	Carraca / Ratchet	-	
2	61447, 61450	Alargadera / Extension	6"-10"	
	61439	Mango en T / T Handle		
1	61436	Articulación universal / Universal joint	-	

COD.		PCS.		
61341	3/8	16	SERIE ESTÁNDAR / STANDARD PATTERN / SÉRIE STANDARD	1,0

PCS./UN.	Composición / Composition / Composition	Descripción / Description / Description		
15	61343, 61344, 61345, 61346, 61347, 61348, 61349, 61350, 61351, 61352, 61353, 61354, 61355, 61356, 61357	Llaves de vaso / Socket wrenches	8-9-10-11-12-13-14-15-16-17- 1-19-20-21-22 mm	
1	62604	Carraca / Ratchet	-	



■ 19 PCS.

COD.		PCS.		
58708	3/8	19	SERIE ESTÁNDAR Y CROWFOOT / STANDARD AND CROWFOOT PATTERN / SÉRIE STANDARD ET CROWFOOT	2,5

PCS./UN.	Composición / Composition / Composition	Descripción / Description / Description		
8	60440, 60441, 60442, 60443, 60444, 60445, 60446, 60447	Llaves de vaso / Socket wrenches	5/16" - 11/32" - 3/8" - 7/16" - 1/2" - 9/16" - 19/32" - 5/8"	
7	55724, 55725, 55726, 55727, 55728, 55729, 55730	Llaves Fijas Crow Foot / Open end Crow Foot wrench	3/8" - 7/16" - 1/2" - 9/16" - 5/8" - 11/16" - 3/4"	
1	62604	Carraca / Ratchet	-	
2	61459, 61449	Alargadera / Extension	3" - 8"	
1	61436	Articulación universal / Universal joint	-	



09

LLAVES DE VASO
SOCKET WRENCHES
DOUILLES
STECKSCHLÜSSEL
BUSSOLE
CHAVES DE CAIXA
ГОЛОВКИ



3/8"

COD.		PCS.		
55596	3/8	19	SERIE ESTÁNDAR / STANDARD PATTERN / SÉRIE STANDARD	1,8
PCS./UN.	Composición / Composition / Composition	Descripción / Description / Description		
14	60439, 60440, 60441, 60442, 60443, 60444, 60445, 60446, 60447, 60448, 60449, 60450, 60451, 60452	Llaves de vaso / Socket wrenches 1/4", 5/16", 11/32", 3/8", 7/16", 1/2", 9/16", 19/32", 5/8", 11/16", 3/4", 13/16", 7/8", 15/16"		
1	62604	Carraca / Ratchet		
2	61447, 61450	Alargadera / Extension 6"-10"		
	61439	Mango en T / T Handle		
1	61436	Articulación universal / Universal joint		



21 PCS.

COD.		PCS.		
55593	3/8	21	SERIE ESTÁNDAR / STANDARD PATTERN / SÉRIE STANDARD	1,7
PCS./UN.	Composición / Composition / Composition	Descripción / Description / Description		
19	67539, 67540, 61343, 61344, 61345, 61346, 61347, 61348, 61349, 61350, 61351, 61352, 61353, 61354, 61355, 61356, 61357, 67560, 67561	Llaves de vaso / Socket wrenches 6-7-8-9-10-11-12-13-14-15-16-17-18-19-20-21-22-23-24 mm		
1	62604	Carraca / Ratchet		
	61447	Alargadera / Extension 6"		



25 PCS.

COD.		PCS.		
58707	3/8	25	SERIE ESTÁNDAR Y CROWFOOT / STANDARD AND CROWFOOT PATTERN / SÉRIE STANDARD ET CROWFOOT	2,5
PCS./UN.	Composición / Composition / Composition	Descripción / Description / Description		
12	61343, 61344, 61345, 61346, 61347, 61348, 61349, 61350, 61351, 61352, 61353, 61354	Llaves de vaso / Socket wrenches 8-9-10-11-12-13-14-15-16-17-18-19 mm		
9	55710, 55711, 55712, 55713, 55714, 55715, 55716, 55717, 55718	Llaves Fijas Crow Foot / Open end Crow Foot wrench 10-11-12-13-14-15-16-17-19 mm		
1	62604	Carraca / Ratchet		
2	61459, 61449	Alargadera / Extension 3"-8"		
1	61436	Articulación universal / Universal joint		



26 PCS.

COD.		PCS.		
55594	3/8	26	SERIE ESTÁNDAR / STANDARD PATTERN / SÉRIE STANDARD	3,0
PCS./UN.	Composición / Composition / Composition	Descripción / Description / Description		
19	67541, 67542, 67543, 67544, 67545, 67546, 67547, 67548, 67549, 67550, 67551, 67552, 67553, 67554, 67555, 67556, 67557, 67558, 67559	Llaves de vaso / Socket wrenches 6-7-8-9-10-11-12-13-14-15-16-17-18-19-20-21-22-23-24 mm		
1	62604	Carraca / Ratchet		
2	61447, 61450	Alargadera / Extension 6"-10"		
	61439	Mango en T / T Handle		
1	61436	Articulación universal / Universal joint		
2	61460, 61461	Llaves de vaso para bujías / Spark plug socket 16 mm-21 mm		



09

LLAVES DE VASO
SOCKET WRENCHES
DOUILLES
STECKSCHLÜSSEL
BUSSOLE
CHAVES DE CAIXA
ГОЛОВКИ



3/8"

30 PCS.

N!

COD.	AF inch	PCS.		Kg
58705	3/8	30	SERIE ESTÁNDAR / STANDARD PATTERN / SÉRIE STANDARD	2,4

PCS./UN.	Composición / Composition / Composition	Descripción / Description / Description		
1	62604	Carraca / Ratchet	-	
	61459	Alargadera / Extension	3"	
7	66771,66772,66773,66774,66775,66776,66777	Punta hexagonal con vaso / Hex bit socket	3-4-5-6-7-8-10 mm	
3	55701,55702,55687	Punta plana con vaso / Flat bit socket	9/64"-7/32"-3/8"	
	66760,66761,66762	Punta plana con vaso / Flat bit socket	5,5 x 1 - 6,5 x 1,2 - 8 x 1,2	
9	66788,66789,66790,66791,66792,66793,66794,66795,66796	Punta Torx con vaso / Torx bit socket	T10-T15-T20-T25-T27-T30-T40-T45-T50	
	66765,66766,66767	Punta Philips con vaso / Philips bit socket	PH1-PH2-PH3	
3	66768,66769,66770	Punta Pozidriv con vaso / Pozidriv bit socket	PZ1 - PZ2 - PZ3	



42 PCS.

COD.	AF inch	PCS.		Kg
61792	3/8	42	SERIE ESTÁNDAR Y LARGA / STANDARD AND LONG PATTERN / SÉRIE STANDARD ET LONGUE	5,5

PCS./UN.	Composición / Composition / Composition	Descripción / Description / Description		
11	61344, 61345, 61346, 61347, 61348, 61349, 61350, 61351, 61352, 61353, 61354	Llaves de vaso / Socket wrenches	9-10-11-12-13-14-15-16-17-18-19 mm	
7	60442, 60443, 60444, 60445, 60447, 60448, 60449		3/8"-7/16"-1/2"-9/16"-5/8"-11/16"-3/4"	
11	67727, 67728, 67729, 67730, 67731, 67732, 67733, 67734, 67735, 67736, 67737	Llaves de vaso serie larga / Long socket wrenches	9-10-11-12-13-14-15-16-17-18-19 mm	
7	67752, 67753, 67754, 67755, 67757, 67758, 67759		3/8"-7/16"-1/2"-9/16"-5/8"-11/16"-3/4"	
1	62604	Carraca / Ratchet	-	
3	61459, 61447, 61449	Alargadera / Extension	3"-6"-8"	
1	61436	Articulación universal / Universal joint	-	
	65875	Mango articulado / Hinged handle	-	



1/2"

11 PCS.

N!

COD.	AF inch	PCS.		Kg
58714	1/2	11	SERIE LARGA / LONG PATTERN / SÉRIE LONGUE	2,5

PCS./UN.	Composición / Composition / Composition	Descripción / Description / Description		
9	67805, 67806, 67807, 67808, 67809, 67810, 67811, 67812, 67813	Llaves de vaso serie larga / Long socket wrenches	3/8"-7/16"-1/2"-9/16"-5/8"-11/16"-3/4"-13/16"-7/8"	
1	62606	Carraca / Ratchet	-	
	61455	Alargadera / Extension	5"	



09

LLAVES DE VASO
SOCKET WRENCHES
DOUILLES
STECKSCHLÜSSEL
BUSSOLE
CHAVES DE CAIXA
ГОЛОВКИ



1/2"

COD.	AF inch	PCS.		Kg
58720	1/2	11	SERIE ESTÁNDAR / STANDARD PATTERN / SÉRIE STANDARD	1,8
PCS./UN.	Composición / Composition / Composition	Descripción / Description / Description		
9	57179,57180,57181,57182,57183,57184,57185,57186,57187	Llaves de vaso TORX / TORX Socket wrenches E10-E11-E12-E14-E16-E18-E20-E22-E24		
1	62606	Carraca / Ratchet		
	61455	Alargadera / Extension 5"		

12 PCS.

COD.	AF inch	PCS.		Kg
58711	1/2	12	SERIE ESTÁNDAR / STANDARD PATTERN / SÉRIE STANDARD	1,7
PCS./UN.	Composición / Composition / Composition	Descripción / Description / Description		
10	61382,61383,61384,61385,61386,61387,61388,61389,61391,61394	Llaves de vaso / Socket wrenches 10-11-12-13-14-15-17-19-22 mm		
1	62606	Carraca / Ratchet		
	61455	Alargadera / Extension 5"		



COD.	AF inch	PCS.		Kg
58713	1/2	12	SERIE LARGA / LONG PATTERN / SÉRIE LONGUE	2,6
PCS./UN.	Composición / Composition / Composition	Descripción / Description / Description		
10	67780,67781,67782,67783,67784,67785,67786,67787,67789,67792	Llaves de vaso serie larga / Long socket wrenches 10-11-12-13-14-15-16-17-19-22 mm		
1	62606	Carraca / Ratchet		
	61455	Alargadera 5"		

COD.	AF inch	PCS.		Kg
58712	1/2	12	SERIE ESTÁNDAR / STANDARD PATTERN / SÉRIE STANDARD	1,8
PCS./UN.	Composición / Composition / Composition	Descripción / Description / Description		
10	60481,60482,60483,60484,60485,60486,60487,60488,60490,60491	Llaves de vaso / Socket wrenches 3/8"-7/16"-1/2"-9/16"-19/32"-5/8"-11/16"-3/4"-13/16"-7/8"		
1	62606	Carraca / Ratchet		
	61455	Alargadera / Extension 5"		





16 PCS.

COD.	AF inch	PCS.		Kg
58723	1/2	16	SERIE ESTÁNDAR Y CROWFOOT / STANDARD AND CROWFOOT PATTERN / SÉRIE STANDARD ET CROWFOOT	2,8
PCS./UN.	Composición / Composition / Composition	Descripción / Description / Description		
8	60487,60488,60489,60490,60491,60492,60495,60497	Llaves de vaso / Socket wrenches 11/16"-3/4"-25/32"-13/16"-7/8"-15/16"-1.1/16"-1.3/16"		
4	57251,57253,57255,57257	Llave fija Crow Foot / Open end Crow Foot wrench 15/16"-1.1/16"-1.3/16"-1.5/16"		
1	62606	Carraca / Ratchet		
2	61453,61458	Alargadera / Extension 3"-10"		
1	61437	Articulación universal / Universal joint		











1/2"





17 PCS.

COD.		PCS.		
61796	1/2	17	SERIE ESTÁNDAR / STANDARD PATTERN / SÉRIE STANDARD	2,0
PCS./UN.	Composición / Composition / Composition	Descripción / Description / Description		
16	61802, 61803, 61804, 61805, 61806, 61807, 61808, 61809, 61810, 61811, 61812, 61814, 61816, 61819, 61822, 61823	Llaves de vaso / Socket wrenches	10-11-12-13-14-15-16-17-18- 19-20-22-24-27-30-32 mm	 -
1	62606	Carraca / Ratchet	-	









COD.		PCS.		
61798	1/2	17	SERIE ESTÁNDAR / STANDARD PATTERN / SÉRIE STANDARD	2,0
PCS./UN.	Composición / Composition / Composition	Descripción / Description / Description		
16	60460, 60461, 60462, 60463, 60464, 60466, 60467, 60468, 60470, 60471, 60472, 60474, 60475, 60476, 60477, 60478	Llaves de vaso / Socket wrenches	5/16"-3/8"-7/16"-1/2"-9/16"- 5/8"-11/16"-3/4"-13/16"-7/8"- 15/16"-1"-1.1/16"-1.1/8"- 1.3/16"-1.1/4"	 -
1	62606	Carraca / Ratchet	-	

COD.		PCS.		
61797	1/2	17	SERIE ESTÁNDAR / STANDARD PATTERN / SÉRIE STANDARD	2,0
PCS./UN.	Composición / Composition / Composition	Descripción / Description / Description		
16	61382, 61383, 61384, 61385, 61386, 61387, 61388, 61389, 61390, 61391, 61392, 61394, 61396, 61399, 61402, 61403	Llaves de vaso / Socket wrenches	10-11-12-13-14-15-16-17-18- 19-20-22-24-27-30-32 mm	 -
1	62606	Carraca / Ratchet	-	

COD.		PCS.		
61799	1/2	17	SERIE ESTÁNDAR / STANDARD PATTERN / SÉRIE STANDARD	2,0
PCS./UN.	Composición / Composition / Composition	Descripción / Description / Description		
16	60480, 60481, 60482, 60483, 60484, 60486, 60487, 60488, 60490, 60491, 60492, 60494, 60495, 60496, 60497, 60498	Llaves de vaso / Socket wrenches	5/16"-3/8"-7/16"-1/2"-9/16"- 5/8"-11/16"-3/4"-13/16"-7/8"- 15/16"-1"-1.1/16"-1.8/8"- 1.3/16"-1.1/4"	 -
1	62606	Carraca / Ratchet	-	

18 PCS.

N!

COD.		PCS.		
58722	1/2	18	SERIE ESTÁNDAR Y CROWFOOT / STANDARD AND CROWFOOT PATTERN / SÉRIE STANDARD ET CROWFOOT	4
PCS./UN.	Composición / Composition / Composition	Descripción / Description / Description		
9	61389, 61390, 61391, 61392, 61393, 61394, 61395, 61399, 61402	Llaves de vaso / Socket wrenches	17-18-19-20-21-22-23-27- 30 mm	 -
5	57226, 57228, 57231, 57234, 57236	Llave fija Crow Foot / Open end Crow Foot wrench	22-24-27-30-32 mm	-
1	62606	Carraca / Ratchet	-	
2	61453, 61458	Alargadera / Extension	3"-10"	
1	61437	Articulación universal	-	



09

LLAVES DE VASO
SOCKET WRENCHES
DOUILLES
STECKSCHLÜSSEL
BUSSOLE
CHAVES DE CAIXA
ГОЛОВКИ



1/2"

N!

COD.		PCS.		
58715	1/2	18	SERIE ESTÁNDAR / STANDARD PATTERN / SÉRIE STANDARD	3,3

PCS./UN.	Composición / Composition / Composition	Descripción / Description / Description		
14	60460,60461,60462,60463,60464, 60465,60466,60459,60467,60468, 60469,60470,60471,60472	Llaves de vaso / Socket wrenches	5/16"-3/8"-7/16"-1/2"-9/16"- 19/32"-5/8"-21/32"-11/16"-3/4"- 25/32"-13/16"-7/8"-15/16"	
1	62606	Carraca / Ratchet	-	
2	61455,61458	Alargadera / Extension	5"-10"	
1	61437	Articulación universal / Universal joint	-	

19 PCS.

COD.		PCS.		
55668	1/2	19	SERIE ESTÁNDAR / STANDARD PATTERN / SÉRIE STANDARD	3,5

PCS./UN.	Composición / Composition / Composition	Descripción / Description / Description		
14	55795,55796,55797,55798,55799, 55801,55803,55804,55805,55806, 55807,55808,55809,55810	Spline / SPLINE	M12, M14, M15, M16, M18, M20, M22, M24, M25, M26, M28, M30, M34, M38	
1	62606	Carraca / Ratchet	-	
2	61455,61458	Alargadera / Extension	5"-10"	
	61440	Mango en T / T Handle	-	
1	61437	Articulación universal / Universal joint	-	



20 PCS.

COD.		PCS.		
55599	1/2	20	SERIE ESTÁNDAR / STANDARD PATTERN / SÉRIE STANDARD	3,5

PCS./UN.	Composición / Composition / Composition	Descripción / Description / Description		
16	61800,61801,61802,61803,61804, 61805,61806,61807,61808,61809, 61810,61811,61813,61814,61815, 61816	Llaves de vaso / Socket wrenches	8-9-10-11-12-13-14-15-16-17-18-19-21- 22-23-24 mm	
1	62606	Carraca / Ratchet	-	
2	61455,61458	Alargadera / Extension	5"-10"	
1	61437	Articulación universal / Universal joint	-	



COD.		PCS.		
55600	1/2	20	SERIE ESTÁNDAR / STANDARD PATTERN / SÉRIE STANDARD	3,0

PCS./UN.	Composición / Composition / Composition	Descripción / Description / Description		
16	61380,61381,61382,61383,61384, 61385,61386,61387,61388,61389, 61390,61391,61393,61394,61395, 61396	Llaves de vaso / Socket wrenches	8-9-10-11-12-13-14-15-16-17-18-19-21- 22-23-24 mm	
1	62606	Carraca / Ratchet	-	
2	61455,61458	Alargadera / Extension	5"-10"	
1	61437	Articulación universal / Universal joint	-	









Si no encuentra el artículo que necesita, consúltenos en info@egamaster.com o en www.egamaster.com
If you can't find the item you look for, please ask us in info@egamaster.com or in www.egamaster.com
Si vous ne trouvez pas l'article que vous desirez, consultez-nous à info@egamaster.com ou à www.egamaster.com

EGA Master
ART IN INNOVATION







1/2"

21 PCS.







COD.		PCS.		
55601	1/2	21	SERIE ESTÁNDAR / STANDARD PATTERN / SÉRIE STANDARD	4,0
PCS./UN.	Composición / Composition / Composition	Descripción / Description / Description		
16	61802, 61803, 61804, 61805, 61806, 61807, 61808, 61809, 61810, 61811, 61813, 61814, 61816, 61819, 61822, 61823	Llaves de vaso / Socket wrenches	10-11-12-13-14-15-16-17-18-19-21- 22-24-27-30-32 mm	
1	62606	Carraca / Ratchet	-	
2	61455, 61458	Alargadera / Extension	5"-10"	
	61440	Mango en T / T Handle	-	
1	61437	Articulación universal / Universal joint	-	









25 PCS.

COD.		PCS.		
61960	1/2	25	SERIE ESTÁNDAR / STANDARD PATTERN / SÉRIE STANDARD	4,5
PCS./UN.	Composición / Composition / Composition	Descripción / Description / Description		
20	61382, 61383, 61384, 61385, 61386, 61387, 61388, 61389, 61390, 61391, 61392, 61393, 61394, 61395, 61396, 61398, 61399, 61400, 61402, 61403	Llaves de vaso / Socket wrenches	10-11-12-13-14-15-16-17-18-19-20- 21-22-23-24-26-27-28-30-32 mm	
1	62606	Carraca / Ratchet	-	
2	61455, 61458	Alargadera / Extension	5"-10"	
	61440	Mango en T / T Handle	-	
1	61437	Articulación universal / Universal joint	-	



COD.		PCS.		
61963	1/2	25	SERIE ESTÁNDAR / STANDARD PATTERN / SÉRIE STANDARD	4,5
PCS./UN.	Composición / Composition / Composition	Descripción / Description / Description		
20	60480, 60481, 60482, 60483, 60484, 60485, 60486, 60479, 60487, 60488, 60489, 60490, 60491, 60492, 60493, 60494, 60495, 60496, 60497, 60498	Llaves de vaso / Socket wrenches	5/16"-3/8"-7/16"-1/2"-9/16"-19/32"- 5/8"-21/32"-11/16"-3/4"-25/32"- 13/16"-7/8"-15/16"-31/32"-1"- 1.1/16"-1.1/8"-1.3/16"-1.1/4"	
1	62606	Carraca / Ratchet	-	
2	61455, 61458	Alargadera / Extension	5"-10"	
	61440	Mango en T / T Handle	-	
1	61437	Articulación universal / Universal joint	-	









COD.		PCS.		
55602	1/2	25	SERIE ESTÁNDAR / STANDARD PATTERN / SÉRIE STANDARD	4,0
PCS./UN.	Composición / Composition / Composition	Descripción / Description / Description		
21	61380, 61381, 61382, 61383, 61384, 61385, 61386, 61387, 61388, 61389, 61390, 61391, 61393, 61394, 61395, 61396, 61398, 61399, 61400, 61402, 61403	Llaves de vaso / Socket wrenches	8-9-10-11-12-13-14-15-16-17-18- 19-20-21-22-23-24-25-26-27-28- 30-32 mm	
	62606	Carraca / Ratchet	-	
	61455	Alargadera / Extension	5"	
1	61440	Mango en T / T Handle	-	
	61437	Articulación universal / Universal joint	-	



1/2"









26 PCS.

N!









COD.		PCS.		
58716	1/2	26	SERIE ESTÁNDAR / STANDARD PATTERN / SÉRIE STANDARD	5
PCS./UN.	Composición / Composition / Composition	Descripción / Description / Description		
20	60460,60461, 60462, 60463, 60464, 60465, 60466, 60459, 60467, 60468, 60469, 60470, 60471, 60472, 60473, 60474, 60475, 60476, 60477, 60478	Llaves de vaso / Socket wrenches	5/16"-3/8"-7/16"-1/2"-9/16"- 19/32"-5/8"-21/32"-11/16"-3/4"- 25/32"-13/16"-7/8"-15/16"-31/32"- 1"-1.1/16"-1.1/8"-1.3/16"-1.1/4"	
1	62606	Carraca / Ratchet	-	
2	61455, 61458	Alargadera / Extension	5"-10"	
	61440	Mango en T / T handle		
1	61437	Articulación universal / Universal joint	-	
	61434	Berbiquí / Speeder Handle		



28 PCS.

COD.		PCS.		
55597	1/2	28	SERIE ESTÁNDAR / STANDARD PATTERN / SÉRIE STANDARD	6,0
PCS./UN.	Composición / Composition / Composition	Descripción / Description / Description		
22	61800, 61801, 61802, 61803, 61804, 61805, 61806, 61807, 61808, 61809, 61810, 61811, 61813, 61814, 61815, 61816, 61818, 61819, 61820, 61821, 61822, 61823	Llaves de vaso / Socket wrenches	8-9-10-11-12-13-14-15-16-17-18-19-21- 22-23-24-26-27-28-29-30-32 mm	
1	62606	Carraca / Ratchet	-	
2	61455, 61458	Alargadera / Extension	5"-10"	
	61440	Mango en T / T Handle		
1	61437	Articulación universal / Universal joint	-	
	61434	Berbiquí / Speeder handle		











COD.		PCS.		
55598	1/2	28	SERIE ESTÁNDAR / STANDARD PATTERN / SÉRIE STANDARD	6,0
PCS./UN.	Composición / Composition / Composition	Descripción / Description / Description		
22	61380, 61381, 61382, 61383, 61384, 61385, 61386, 61387, 61388, 61389, 61390, 61391, 61393, 61394, 61395, 61396, 61398, 61399, 61400, 61401, 61402, 61403	Llaves de vaso / Socket wrenches	8-9-10-11-12-13-14-15-16-17-18-19-21-22-23- 24-26-27-28-29-30-32 mm	
1	62606	Carraca / Ratchet	-	
2	61455, 61458	Alargadera / Extension	5"-10"	
	61440	Mango en T / T Handle		
1	61437	Articulación universal / Universal joint	-	
	61434	Berbiquí / Speeder handle		



1/2"







30 PCS.

N!

COD.		PCS.		
58721	1/2	30	SERIE ESTÁNDAR / STANDARD PATTERN / SÉRIE STANDARD	5
PCS./UN.	Composición / Composition / Composition	Descripción / Description / Description		
1	62606	Carraca / Ratchet		
	61455	Alargadera / Extension		
10	66807,66808,66809,66810,66811,66812, 66813,55706,66814,55708	Punta hexagonal con vaso / Hex bit socket	4-5-6-7-8-10-12-13-14-17 mm	
	55704,55705,55707		7/32"-3/8"-3/4"	
3	66801,66802,66803	Punta plana con vaso / Flat bit socket	8 x 1,2 - 10 x 1,6 - 12 x 2	
	66804,66805,66806	Punta philips con vaso / Philips bit socket	PH-2-PH3-PH4	
9	66830,66831,66832,66833,66834,66835,6 6836,66837,56895	Punta Torx con vaso / Torx bit socket	T20-T25-T27-T30-T40-T45-T50-T55-T60	













35 PCS.

COD.		PCS.		
55603	1/2	35	SERIE ESTÁNDAR / STANDARD PATTERN / SÉRIE STANDARD	6,0
PCS./UN.	Composición / Composition / Composition	Descripción / Description / Description		
11	61802, 61803, 61805, 61806, 61809, 61811, 61814, 61816, 61819, 61822, 61823	10-11-13-14-17-19-22-24-27-30-32 mm		
19	60460, 60461, 60459, 60462, 60463, 60464, 60465, 60466, 60467, 60468, 60469, 60470, 60471, 60472, 60474, 60475, 60476, 60477, 60478	Llaves de vaso / Socket wrenches		
			5/16"-3/8"-7/16"-1/2"-9/16"-19/32"-5/8"- 21/32"-11/16"-3/4"-25/32"-13/16"-7/8"- 15/16"-1"-1.1/16"-1.1/8"-1.3/16"-1.1/4"	
1	62606	Carraca / Ratchet		
2	61455, 61458	Alargadera / Extension		
	61437	Articulación universal / Universal joint		
1	61434	Berbiquí / Speeder handle		



41 PCS.

COD.		PCS.		
61793	1/2	41	SERIE ESTÁNDAR / STANDARD PATTERN / SÉRIE STANDARD	5,5
PCS./UN.	Composición / Composition / Composition	Descripción / Description / Description		
18	61382, 61383, 61384, 61385, 61386, 61387, 61388, 61389, 61390, 61391, 61392, 61393, 61394, 61395, 61396, 61399, 61402, 61403	Llaves de vaso / Socket wrenches		
			10-11-12-13-14-15-16-17-18-19-20-21-22- 23-24-27-30-32 mm	
15	60481, 60482, 60483, 60484, 60486, 60487, 60488, 60490, 60491, 60492, 60494, 60495, 60496, 60497, 60498	Llaves de vaso para bujías / Spark plug socket		
			3/8"-7/16"-1/2"-9/16"-5/8"-11/16"-3/4"- 13/16"-7/8"-15/16"-1"-1.1/16"-1.1/8"- 1.3/16"-1.1/4"	
1	62606	Carraca / Ratchet		
2	61455, 61458	Alargadera / Extension		
	61440	Mango en T / T Handle		
1	61437	Articulación universal / Universal joint		
	61441	Mango articulado / Hinged handle		
2	61462, 61463	Llaves de vaso para bujías / Spark plug socket		



09

LLAVES DE VASO
SOCKET WRENCHES
DOUILLES
STECKSCHLÜSSEL
BUSSOLE
CHAVES DE CAIXA
ГОЛОВКИ



Management System
ISO 9001:2015
ISO 14001:2015
www.tuc.com
ID 0910598048



1/2"

33 PCS.

COD.		PCS.	SERIE LARGA / LONG PATTERN / SÉRIE LONGUE		
65074	1/2	33			6,0
PCS./UN.	Composición / Composition / Composition		Descripción / Description / Description		
15	61382, 61383, 61384, 61385, 61386, 61387, 61388, 61389, 61390, 61391, 61392, 61393, 61394, 61395, 61396		Llaves de vaso / Socket wrenches 10-11-12-13-14-15-16-17-18-19-20-21- 22-23-24 mm		
10	67780, 67781, 67782, 67783, 67784, 67785, 67786, 67787, 67788, 67789		Llaves de vaso serie larga / Long socket wrenches 10-11-12-13-14-15-16-17-18-19 mm		
1	62606		Carraca / Ratchet		
3	61453, 61455, 61458		Alargadera / Extension 3"-5"-10"		
	61441		Mango articulado / Hinged handle		
1	61437		Articulación universal / Universal joint		
2	61462, 61463		Llaves de vaso para bujías / Spark plug socket 16 mm-21 mm		



COD.		PCS.	SERIE LARGA / LONG PATTERN / SÉRIE LONGUE		
65075	1/2	33			7,0
PCS./UN.	Composición / Composition / Composition		Descripción / Description / Description		
15	60481, 60482, 60483, 60484, 60486, 60487, 60488, 60490, 60491, 60492, 60494, 60495, 60496, 60497, 60498		Llaves de vaso / Socket wrenches 3/8"-7/16"-1/2"-9/16"-5/8"-11/16"-3/4"- 13/16"-7/8"-15/16"-1"-1.1/16"-1.1/8"- 1.3/16"-1.1/4"		
10	67805, 67806, 67807, 67808, 67809, 67810, 67811, 67812, 67813, 67814		Llaves de vaso serie larga / Long socket wrenches 3/8"-7/16"-1/2"-9/16"-5/8"-11/16"-3/4"- 13/16"-7/8"-15/16"		
1	62606		Carraca / Ratchet		
3	61453, 61455, 61458		Alargadera / Extension 3"-5"-10"		
	61441		Mango articulado / Hinged handle		
1	61437		Articulación universal / Universal joint		
2	61462, 61463		Llaves de vaso para bujías / Spark plug socket 5/8"-13/16"		

1/4" - 1/2"

18 PCS.

COD.		PCS.	SERIE ESTÁNDAR / STANDARD PATTERN / SÉRIE STANDARD		
58726	1/2, 1/4	18			2,5
PCS./UN.	Composición / Composition / Composition		Descripción / Description / Description		
7	61385, 61386, 61387, 61388, 61389, 61391, 61394		Llaves de vaso 1/2" / Socket wrenches 1/2" 13-14-15-16-17-19-22 mm		
1	62606		Carraca 1/2" / Ratchet 1/2"		
	61455		Alargadera 1/2" / Extension 1/2" 5"		
7	61311, 63974, 63977, 63979, 63980, 63981, 63983		Llaves de vaso 1/4" / Socket wrenches 1/4" 4-4,5-5-6-7-8-10 mm		
1	62603		Carraca 1/4" / Ratchet 1/4"		
	61454		Alargadera 1/4" / Extension 1/4" 3"		



Si no encuentra el artículo que necesita, consúltenos en info@egamaster.com o en www.egamaster.com
If you can't find the item you look for, please ask us in info@egamaster.com or in www.egamaster.com
Si vous ne trouvez pas l'article que vous désirez, consultez-nous à info@egamaster.com ou à www.egamaster.com

EGA Master
ART IN INNOVATION

387

1/4" - 1/2"



N!

COD.		PCS.		
58727	1/2, 1/4	19	SERIE ESTÁNDAR / STANDARD PATTERN / SÉRIE STANDARD	3,0

PCS./UN.	Composición / Composition / Composition	Descripción / Description / Description		
7	60483,60484,60485,60486,60487,60488,60491	Llaves de vaso 1/2" / Socket wrenches 1/2"	1/2"-9/16"-19/32"-5/8"-11/16"-3/4"-7/8"	 -
1	62606	Carraca 1/2" / Ratchet 1/2"	-	
2	61453, 61458	Alargadera 1/2" / Extension 1/2"	3"-10"	
1	61437	Articulación universal 1/2" / Universal joint 1/2"	-	
7	60420,60421,63991,63992,63993,63995,63996	Llaves de vaso 1/4" / Socket wrenches 1/4"	5/32"-3/16"-1/4"-9/32"-5/16"-3/8"-7/16"	-
1	62603	Carraca 1/4" / Ratchet 1/4"	-	



N!





COD.		PCS.		
58728	1/2, 1/4	19	SERIE LARGA / LONG PATTERN / SÉRIE LONGUE	3,7

PCS./UN.	Composición / Composition / Composition	Descripción / Description / Description		
7	67783, 67784, 67785, 67786, 67787, 67789, 67792	Llaves de vaso serie larga 1/2" / Long socket wrenches 1/2"	13-14-15-16-17-19-22 mm	 -
1	62606	Carraca 1/2" / Ratchet 1/2"	-	
2	61453, 61458	Alargadera 1/2" / Extension 1/2"	3"-10"	
1	61437	Articulación universal 1/2" / Universal joint 1/2"	-	
7	67640,67641,67660,67662,67663,67664, 67666	Llaves de vaso serie larga 1/4" / Long socket wrenches 1/4"	4-4,5-5-6-7-8-10 mm	-
1	62603	Carraca 1/4" / Ratchet	-	

■ 3/4"





■ 14 PCS.

COD.		PCS.		
61861	3/4	14	SERIE ESTÁNDAR / STANDARD PATTERN / SÉRIE STANDARD	12

PCS./UN.	Composición / Composition / Composition	Descripción / Description / Description		
10	60503, 60505, 60508, 60511, 60512, 60516, 60517, 60519, 60521, 60522	Llaves de vaso / Socket wrenches	22-24-27-30-32-36-38-41-46-50 mm	 -
1	61859	Carraca / Ratchet	-	
2	61865, 61866	Alargadera / Extension	4"-8"	
1	61864	Mango en T / T Handle	-	



COD.		PCS.		
61862	3/4	14	SERIE ESTÁNDAR / STANDARD PATTERN / SÉRIE STANDARD	12

PCS./UN.	Composición / Composition / Composition	Descripción / Description / Description		
10	60527, 60528, 60529, 60531, 60532, 60535, 60536, 60537, 60539, 60541	Llaves de vaso / Socket wrenches	7/8"-15/16"-1"-1.1/8"-1.1/4"-1.7/16"-1.1/2"-1.5/8"-1.13/16"-2"	 -
1	61859	Carraca / Ratchet	-	
2	61865, 61866	Alargadera / Extension	4"-8"	
1	61864	Mango en T / T Handle	-	

09





LLAVES DE VASO
SOCKET WRENCHES
DOUILLES
STECKSCHLÜSSEL
BUSSOLE
CHAVES DE CAIXA
ГОЛОВКИ



■ 1"





■ 14 PCS.

COD.	AF inch	PCS.		Kg
65041	1	14	SERIE ESTÁNDAR / STANDARD PATTERN / SÉRIE STANDARD	27

PCS./UN.	Composición / Composition / Composition	Descripción / Description / Description		
10	65001, 65002, 65003, 65004, 65006, 65008, 65010, 65012, 65014, 65016	Llaves de vaso / Socket wrenches	36-41-46-50-55-60-65-70-75-80 mm	 -
1	65035	Carraca / Ratchet	-	
2	65037, 65038	Alargadera / Extension	8"-16"	
1	65036	Mango en T / T Handle	-	



COD.	AF inch	PCS.		Kg
65042	1	14	SERIE ESTÁNDAR / STANDARD PATTERN / SÉRIE STANDARD	27



PCS./UN.	Composición / Composition / Composition	Descripción / Description / Description		
10	65023, 65024, 65025, 65027, 65028, 65029, 65030, 65031, 65032, 65034	Llaves de vaso / Socket wrenches	1.13/16"-1.7/8"-2"-2.3/16"-2.1/4"-2.3/8"-2.1/2"-2.5/8"-2.3/4"-3.1/8"	 -
1	65035	Carraca / Ratchet	-	
2	65037, 65038	Alargadera / Extension	8"-16"	
1	65036	Mango en T / T Handle	-	

■ EXPOSITORES / DISPLAYS / PRESENTOIRS / DISPLAY / ESPOSITORE / DISPLAY STAND / СТЕНДЫ



■ 1/2"

■ 233 PCS.

COD.	AF inch	PCS.		Kg
65296	1/2	233	SERIE ESTÁNDAR / STANDARD PATTERN / SERIE ESTÁNDAR	34

PCS./UN.	Composición / Composition / Composition	Descripción / Description / Description		
96	61800, 61801, 61802, 61803, 61804, 61805, 61806, 61807	Llaves de vaso / Socket wrenches	8-9-10-11-12-13-14-15 mm	 -
22	61808, 61809		16-17 mm	
20	61810, 61811		18-19 mm	
18	61812, 61813		20-21 mm	
24	61814, 61815, 61816		22-23-24 mm	
35	61817, 61818, 61819, 61820, 61821		25-26-27-28-29 mm	
12	61822, 61823	30-32 mm		
6	61430	Carraca / Ratchet	-	

COD.	AF inch	PCS.		Kg
65297	1/2	233	SERIE ESTÁNDAR / STANDARD PATTERN / SÉRIE STANDARD	34

PCS./UN.	Composición / Composition / Composition	Descripción / Description / Description		
96	61380, 61381, 61382, 61383, 61384, 61385, 61386, 61387	Llaves de vaso / Socket wrenches	8-9-10-11-12-13-14-15 mm	 -
22	61388, 61389		16-17 mm	
20	61390, 61391		18-19 mm	
18	61392, 61393		20-21 mm	
24	61394, 61395, 61391		22-23-24 mm	
35	61397, 61398, 61399, 61400, 61401		25-26-27-28-29 mm	
12	61402, 61403	30-32 mm		
6	62606	Carraca / Ratchet	-	



09

LLAVES DE VASO
 SOCKET WRENCHES
 DOUILLES
 STECKSCHLÜSSEL
 BUSSOLE
 CHAVES DE CAIXA
 ГОЛОВКИ



1/2"

236 PCS.

COD.	AF inch	PCS.		Kg
65298	1/2	236	SERIE ESTÁNDAR / STANDARD PATTERN / SÉRIE STANDARD	33
PCS./UN.	Composición / Composition / Composition	Descripción / Description / Description		
48	60460, 60461	5/16"-3/8"		
24	60462, 60463	7/16"-1/2"		
	60464	9/16"		
22	60466	5/8"		
20	60467	11/16"		
19	60468	3/4"		
9	60470	13/16"		
16	60471	7/8"		
8	60472	15/16"		
14	60474	1"		
	60475, 60476	1.1/16"-1.1/8"		
12	60477, 60478	1.3/16"-1.1/4"		
6	61430	Carraca / Ratchet		



COD.	AF inch	PCS.		Kg
65299	1/2	236	SERIE ESTÁNDAR / STANDARD PATTERN / SÉRIE STANDARD	32
PCS./UN.	Composición / Composition / Composition	Descripción / Description / Description		
48	60480, 60481	5/16"-3/8"		
	60482, 60483, 60484, 60485	7/16"-1/2"-9/16"-19/32"		
22	60486, 60479	5/8"-21/32"		
20	60487	11/16"		
10	60488	3/4"		
18	60489, 60490	25/32"-13/16"		
16	60491	7/8"		
8	60492	15/16"		
28	60493, 60494, 60495, 60496	31/32"-1"-1.1/16"-1.1/8"		
12	60497, 60498	1.3/16"-1.1/4"		
6	62606	Carraca / Ratchet		

3/4"

86 PCS.

COD.	AF inch	PCS.		Kg
65300	3/4	86	SERIE ESTÁNDAR / STANDARD PATTERN / SÉRIE STANDARD	38
PCS./UN.	Composición / Composition / Composition	Descripción / Description / Description		
35	60501, 60503, 60505, 60507, 60508	19-22-24-26-27 mm		
18	60510, 60511, 60512	29-30-32 mm		
25	60514, 60515, 60516, 60517, 60519	34-35-36-38-41 mm		
8	60521, 60522	46-50 mm		



COD.	AF inch	PCS.		Kg
65301	3/4	86	SERIE ESTÁNDAR / STANDARD PATTERN / SÉRIE STANDARD	39
PCS./UN.	Composición / Composition / Composition	Descripción / Description / Description		
14	60527	7/8"		
21	60528, 60529, 60530	15/16"-1"-1.1/16"		
6	60531	1.1/8"		
12	60532	1-1/4"		
25	60533, 60534, 60535, 60536, 60537	1.5/16"-1.3/8"-1.7/16"-1.1/2"-1.5/8"		
8	60539, 60541	1.13/16"-2"		

LLAVES DE VASO DE IMPACTO / IMPACT SOCKET WRENCHES / DOUILLES À CHOC / KRAFTSCHRAUBEREINSATZ / BUSSOLA AD IMPULSI / CHAVES DE CAIXA DE IMPACTO / УДАРНЫЕ ГОЛОВКИ

- 3/8"
- 6 PT.
- STANDARD
- MM

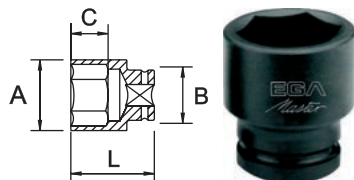

COD.	AF mm	L (mm)	A (mm)	B (mm)	C (mm)	Pt	g	Icon 1	Icon 2
60590	7		12				41		
60591	8		13						
60592	9		14	19	14		43		
60593	10		16						
60594	11		17				44		
60595	12		18						
60596	13	30	20	20	15	6		6	●
60597	14		21	21					
60598	15		22	22			60		
60599	16		23	23	16				
60600	17		24	24					
60601	18		26	26					
60602	19		27	27			70		

 DIN 3129

CARACTERÍSTICAS / FEATURES / CARACTÉRISTIQUES

Cr-V

- INCH

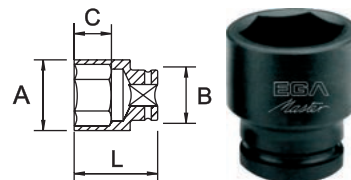

COD.	AF inch	L (mm)	A (mm)	B (mm)	C (mm)	Pt	g	Icon 1	Icon 2
65205	5/16		13				43		
65206	3/8		15	19	14				
65207	7/16		17				44		
65208	1/2		19		15				
65209	9/16		21	21					
65210	5/8	30	23	23		6	60	6	●
65211	11/16		25	25	16				
65212	3/4		27	27			70		
68685	13/16		30	30			100		
68686	7/8		32	32			125		

 DIN 3129

CARACTERÍSTICAS / FEATURES / CARACTÉRISTIQUES

Cr-V

PUNTAS ATORNILLADORAS DE IMPACTO CON VASO / IMPACT SOCKET BITS / EMBOUTS SUR DOUILLE MONOBLOC IMPACT / STECKSCHLÜSSEL BITS / INSERTI A BUSSOLA IMPACT / PONTAS APARAFUSADORAS DE IMPACTO COM CHAVE DE CAIXA / УДАРНАЯ ГОЛОВКА ДЛЯ БИТ
HEXAGONAL / HEXAGONAL / HEXAGONALE / HEXAGONAL / ESAGONALE / HEXAGONAL / ШЕСТИГРАННАЯ

COD.	mm	L (mm)	g	Icon 1	Icon 2
65920	3		45		
65921	4		50		
65922	5				
65923	6	78	55		
65924	8		65	10	●
65925	10		85		
65926	12		100		
65927	14		120		



TORX®*

COD.	mm	L (mm)	g	Icon 1	Icon 2
65928	T25		40		
65929	T27				
65930	T30				
65931	T40	60	45		
65932	T45		50	10	●
65933	T50		55		
65934	T55		65		
65935	T60		75		

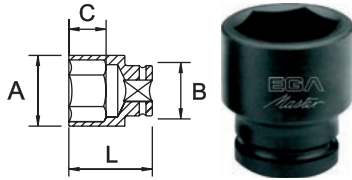

*Para tornillos TORX® (Marca registrada por Acument Intellectual Properties, LLC, Troy, Mich., US) / *For screws TORX® (Acument Intellectual Properties, LLC, Troy, Mich., US registered trademark) / *Pour vis TORX® (Marque enregistrée par Acument Intellectual Properties, LLC, Troy, Mich., US)

- 1/2"
- 6 PT.
- STANDARD
- MM



- INCH

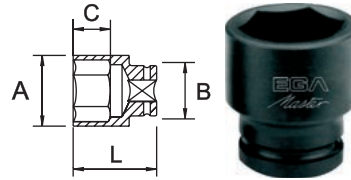

COD.	AF mm	L (mm)	A (mm)	B (mm)	C (mm)	Pt	g	Icon 1	Icon 2
60658	8						6		
57987	9		17				65		1
60603	10								
60604	11		19		15				
60605	12		20	24					
60606	13		22				80		
60607	14								
60608	15		24						
60609	16				16				
60610	17		26	26			95		
60611	18	38	28	28				6	
60612	19						110		
60639	20		29	29	18	6			
60613	21		30	30			120		
60614	22		32	32			140		
58450	23		34	34			160		
60615	24				20				
58451	25		36	36			190		
60616	27		38				185		
57988	28		40	35	21		190	1	
60617	29						200		
60618	30	43	42	42	20			6	
60619	32	38	44	35			210		
57989	33		46,5				240		1
57990	34	48	46,8	30	23		250		
60712	36	50	50	36			350		6

● I DIN 3129

CARACTERÍSTICAS / FEATURES / CARACTÉRISTIQUES

Cr-V

COD.	AF inch	L (mm)	A (mm)	B (mm)	C (mm)	Pt	g	Icon 1	Icon 2
65213	3/8		16						
65214	7/16		18						
65215	1/2		20		14		85		
65216	9/16		22						
65217	5/8		24	24	15				
65218	11/16		26	26					
65219	3/4		28	28	16		125	6	
65220	13/16	38	30	30	19	6			●
65221	7/8		32	32			130		
65222	15/16		34	34	20		135		
65223	1		36				145		
65224	1.1/16		38				170		
65225	1.1/8		40	35	21		190		1
57985	1.3/16		42				200		6
65226	1.1/4		44						

● I DIN 3129

CARACTERÍSTICAS / FEATURES / CARACTÉRISTIQUES

Cr-V

1/2"

■ 6 PT.

■ SERIE LARGA / LONG SOCKETS / SÉRIE LONGUE / LANGE SERIE / SERIE LUNGA / SERIE LONGA / ВЫСОКАЯ СЕРИЯ

■ MM

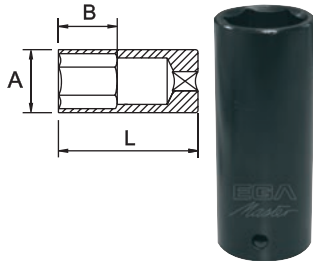

■ INCH

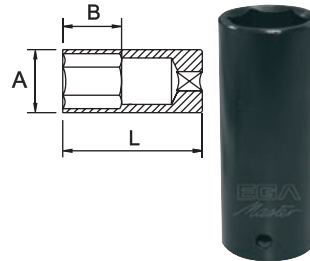

COD.	AP mm	L (mm)	A (mm)	B (mm)	Pt	g	Icon 1	Icon 2
57994	9		16	24		140		1
60660	10		17					
60661	11		18	27				
60662	12		19					
60663	13		20					
60664	14		22	37	190		6	
58452	15		24	34				
60665	16							
60666	17		26					
60667	18		27					
60668	19	80	28		6			●
57995	20		30			260		1
60669	21		31					
60670	22		32	37		310		
60671	23		33			320		
60672	24		34			340		6
60673	27		38			400		
60674	29		40			420		
60675	30		42			430		
60676	32		44			450		
57996	34		47	38		500		1

● | DIN 3129

CARACTERÍSTICAS / FEATURES / CARACTÉRISTIQUES

Cr-V

COD.	AP inch	L (mm)	A (mm)	B (mm)	Pt	g	Icon 1	Icon 2
55630	3/8		18	24				
55631	7/16							
55632	1/2		20		190			
55633	9/16		22	29				
55634	5/8		24					
55635	11/16		26					
55636	3/4		28			220	6	
55637	13/16	80	30		6	250		●
55638	7/8		32			290		
55639	15/16		34	36		320		
55640	1		36					
55641	1.1/16		38			370		
55642	1.1/8		40					
57992	1.3/16		42			390	1	
55643	1.1/4		44			420	6	

● | DIN 3129

CARACTERÍSTICAS / FEATURES / CARACTÉRISTIQUES

Cr-V

1/2"

- 8 PT.
- STANDARD
- INCH

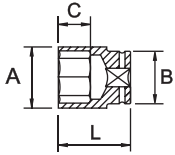

COD.	AF inch	L (mm)	A (mm)	B (mm)	C (mm)	Pt	g		
56350	3/8	38	19		6		70		
56351	7/16		21	24	8		75		
56352	1/2		24		9		80		
56353	9/16		26	26			95		
56354	5/8		28	28	11		110		
56355	11/16	30	30			125			
56356	3/4	40	34	34	13	8	180	6	●
56357	13/16		36	36		15	195		
56358	7/8		38				220		
56359	15/16	45	42	38			285		
56360	1		44		18		300		
56361	1.1/16	50	46,5	46,5			430		
56362	1.1/8		49	49	19		600		



CARACTERÍSTICAS / FEATURES / CARACTÉRISTIQUES

Cr-V

PUNTAS ATORNILLADORAS DE IMPACTO CON VASO / IMPACT SOCKET BITS / EMBOUTS DE VISSAGE CHOCS À DOUILLE / STECKSCHLÜSSEL BITS / INSERTI A BUSSOLA IMPACT /
 PONTAS APARAFUSADORAS DE IMPACTO COM CHAVE DE CAIXA / УДАРНАЯ ГОЛОВКА ДЛЯ БИТ

HEXAGONAL / HEXAGONAL / HEXAGONALE / HEXAGONAL / ESAGONALE / HEXAGONAL / ШЕСТИГРАННАЯ

COD.	mm	L (mm)	g		
65936	4	78	80		
65937	5		85		
65938	6		95		
65939	8		110	10	●
65940	10		120		
65941	11		125		
65942	12		140		
65943	14		170		
65944	17		200		
65945	19				



N!

COD.	mm	L (mm)	g		
58660	5	170	260		
58661	6		270		
58662	8		345	10	●
58663	10		350		
58664	12		420		
58665	14		430		



09

**LLAVES DE VASO
SOCKET WRENCHES
DOUILLES
STECKSCHLÜSSEL
BUSSOLE
CHAVES DE CAIXA
ГОЛОВКИ**



1/2"

TORX®*

COD.		L (mm)			
65946	T25	78	75	10	●
65947	T27				
65948	T30				
65949	T40				
65950	T45		80		
65951	T50		85		
65952	T55		90		
65953	T60		110		
			120		



3/4"

4 PT.

STANDARD

MM

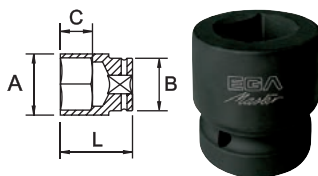

COD.		L (mm)	A (mm)	B (mm)	C (mm)	Pt			
57190	22	50	44	44	24	4	240	1	●
57191	24		250						
57192	27		270						
57193	30		420						



CARACTERÍSTICAS / FEATURES / CARACTÉRISTIQUES

Cr-V

INCH

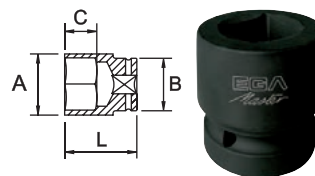

COD.		L (mm)	A (mm)	B (mm)	C (mm)	Pt			
56394	5/8	52	32	40	13	4	285	1	●
56395	11/16		295						
56396	13/16		380						



CARACTERÍSTICAS / FEATURES / CARACTÉRISTIQUES

Cr-V

EGGA Master

ART IN INNOVATION

* Para tornillos TORX® (Marca registrada por Acument Intellectual Properties, LLC, Troy, Mich., US) / *For screws TORX® (Acument Intellectual Properties, LLC, Troy, Mich., US registered trademark) / *Pour vis TORX® (Marque enregistrée par Acument Intellectual Properties, LLC, Troy, Mich., US)

3/4"

- 6 PT.
- STANDARD
- MM

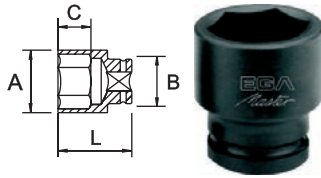

■ INCH

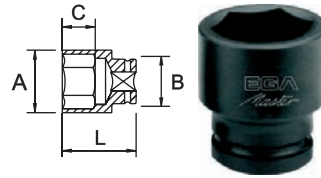

COD.	AF mm	L (mm)	A (mm)	B (mm)	C (mm)	Pt	g	Icon 1	Icon 2
63879	17		30				220		
60620	19		33						
57335	20		35		18				
60621	21		37		18				
60622	22	50	37	38					
60623	23		38				230		
60624	24		39		22				
57336	25		40		23				
60625	26		41		24				
60626	27		43	40	26				
60627	28		44						
60628	29		45	42			310		
60629	30		46				420		
57337	31		46				430		
60630	32		49				440		
60631	33		49				460		
60632	34	55	50				480		
58454	35		51		27	6	460	1	
60633	36		51				500		
60634	38		55				550		
57338	39		55				560		
57339	40			44			570		
60635	41		60				600		
60636	42		60				700		
58455	43		61				610		
57340	44	60	60						
57341	45						700		
60637	46	65	65						
57342	47				28				
63880	48								
60638	50	70	70				1100		
57345	51								
63881	54			55	32				
63891	55	75	75				1250		
63921	60		85		43		1300		

● I DIN 3129

CARACTERÍSTICAS / FEATURES / CARACTÉRISTIQUES

Cr-Mo

COD.	AF inch	L (mm)	A (mm)	B (mm)	C (mm)	Pt	g	Icon 1	Icon 2
58453	11/16		29	38	16		220		
65227	3/4		33						
65228	13/16		35						
65229	7/8	50	37		18				
65230	15/16		39				230		
65231	1		41		22				
65232	1.1/16		43		26				
65233	1.1/8		45				310		
65234	1.3/16		46				420		
65235	1.1/4	55	49				440		
65236	1.5/16		50				460		
65237	1.3/8			44			480		
65238	1.7/16		55		27		500		
65239	1.1/2					6	550	1	
68689	1.9/16		58						
65240	1.5/8	60	60				600		
65241	1.11/16								
65242	1.3/4		65				700		
57344	1.13/16								
65243	1.7/8	65	70				750		
57346	1.15/16								
65244	2				28				
57347	2.1/16	70	75				1100		
57354	2.3/32			55					
57348	2.1/8								
68688	2.3/16	75	80				1350		
57999	2.1/4				35		1450		

● I DIN 3129

CARACTERÍSTICAS / FEATURES / CARACTÉRISTIQUES

Cr-Mo

09

**LLAVES DE VASO
SOCKET WRENCHES
DOUILLES
STECKSCHLÜSSEL
BUSSOLE
CHAVES DE CAIXA
ГОЛОВКИ**



3/4"

■ 6 PT.

■ SERIE LARGA / LONG SOCKETS / SÉRIE LONGUE / LANGE SERIE / SERIE LUNGA / SERIE LONGA / ВЫСОКАЯ СЕРИЯ

■ MM

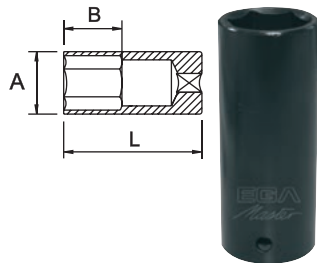

■ INCH

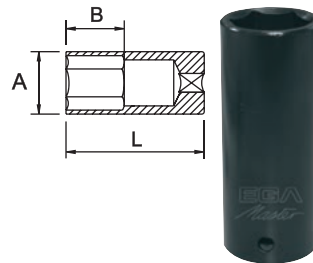

COD.	AF mm	L (mm)	A (mm)	B (mm)	Pt	g	Icon 1	Icon 2
60679	19		33					
57349	20		34					
60680	21		35		600			
60681	22		37	28				
57350	23		39					
60682	24		40					
57351	25		41	36				
60683	26		42	50	650			
60684	27		44					
57352	28		45					
57353	29		46	55				
60685	30	90	49		6	850	1	
60686	32		50			900		
60687	33		55	60		950		
60688	34		60					
60689	36		61	44		940		
60690	38		65	65		1100		
60691	41		70	70		1200		
63895	42							
58456	43							
63945	44							
63896	48							
63897	50							

○ | DIN 3129

CARACTERÍSTICAS / FEATURES / CARACTÉRISTIQUES

Cr-Mo

COD.	AF inch	L (mm)	A (mm)	B (mm)	Pt	g	Icon 1	Icon 2
58001	3/4		33					
58002	13/16		35		550			
58003	7/8		37	26	600			
58004	15/16		38					
65245	1		40		550			
65246	1.1/16		42		600			
65247	1.1/8		44	28	650			
65248	1.3/16		46		700			
65249	1.1/4		48					
65250	1.5/16		50	30	750			
65251	1.3/8		55	34	6	800	1	
57360	1.7/16	90	61	54		940		
65252	1.1/2		55			1000		
58005	1.9/16		60	42		940		
57361			65	42		1000		
57362	1.5/8		65	65		1100		
57363	1.11/16		70	65		1150		
58006	1.5/8							
63946	1.3/4							
57364	1.13/16							
57365	1.7/8							
57366	1.15/16							
57367	2							

○ | DIN 3129

CARACTERÍSTICAS / FEATURES / CARACTÉRISTIQUES

Cr-Mo

3/4"

- 8 PT.
- STANDARD
- INCH

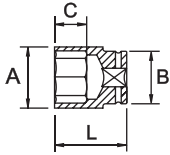

COD.	AF inch	L (mm)	A (mm)	B (mm)	C (mm)	Pt	g		
56363	5/8		32				275		
56364	11/16		34	40	13		280		
56365	3/4	50	40				320		
56366	13/16		42	42			360		
56367	7/8		44		15		395		
56368	15/16		46				425		
56369	1	52	50			18	485		
56370	1.1/16		53				555	1	●
56371	1.1/8	54	56	44	19		585		
56372	1.3/16		58		21		630		
56373	1.1/4		61		22		705		
56374	1.5/16	56	63.5				735		
56375	1.7/16		68		24		765		
56376	1.1/2	58	70				860		



CARACTERÍSTICAS / FEATURES / CARACTÉRISTIQUES

Cr-V

PUNTAS ATORNILLADORAS DE IMPACTO CON VASO / IMPACT SOCKET BITS / EMBOUTS DE VISSAGE CHOC À DOUILLE / STECKSCHLÜSSEL BITS / INSERTI A BUSSOLA IMPACT /
 PONTAS APARAFUSADORAS DE IMPACTO COM CHAVE DE CAIXA / УДАРНАЯ ГОЛОВКА ДЛЯ БИТ

HEXAGONAL / HEXAGONAL / HEXAGONALE / HEXAGONAL / ESAGONALE / HEXAGONAL / ШЕСТИГРАННАЯ

N!

COD.	mm	L (mm)	g		
58731	10		490		
58732	12		500		
58733	14		550		
58734	17		600		
58735	19	100	600	10	●
58736	22		700		
58737	24		700		
58738	27		850		
58739	30				
58740	32				



- 1"
- 4 PT.
- STANDARD
- MM

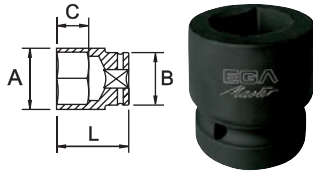

- INCH

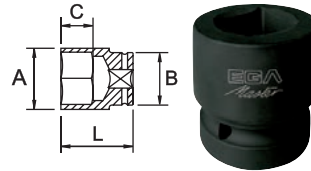

COD.	AF mm	L (mm)	A (mm)	B (mm)	C (mm)	Pt	g	Icon 1	Icon 2
57194	17		40				320		
57195	18		42				340		
57196	20			50	24		350		
57197	21		44				360		
57198	22	60				4	370	1	●
57199	23		48						
57200	24		50				500		
57201	27		55	55	27				
57202	30		60				550		



CARACTERÍSTICAS / FEATURES / CARACTÉRISTIQUES

Cr-V

COD.	AF inch	L (mm)	A (mm)	B (mm)	C (mm)	Pt	g	Icon 1	Icon 2
56397	3/4	57	43	52	13		550		
56398	13/16		44			15			
56399	7/8		48						
56400	15/16	60	50			4	700	1	●
56401	1		53	54	18				
56402	1.1/8		60		19		850		
56403	1.1/2	75	75		24		1450		-



CARACTERÍSTICAS / FEATURES / CARACTÉRISTIQUES

Cr-V

EGA Master

ART IN INNOVATION

1"

- 6 PT.
- STANDARD
- MM

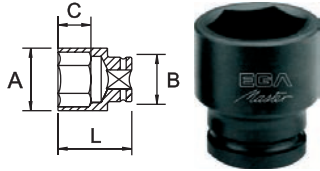

COD.	AF mm	L (mm)	A (mm)	B (mm)	C (mm)	Pt	g	Icon 1	Icon 2
57372	20		37						
57373	21		38						
57374	22		39			500			
57375	23	60	40						
65534	24		42	50					
57376	25		44		23				
57377	26		45						
65535	27		46			550			
57378	28		48						
57379	29		49						
65536	30		50						
57380	31		53						
65537	32		55			600			
57140	33		53		26				
57141	34	65	53			650			
57142	35		55						
65538	36		55			700			
57381	37		60						
60640	38		60			800			
57382	39		65						
63882	40		65						
60641	41		65		28	6	850	1	
60642	42		70						
57383	44	70	75			900			
57384	45		75			950			
60643	46		75	55					
57385	47	75	75			1050			
63890	48		75		32				
60644	50		80						
60645	52	80	85			1100			
60646	54		85			1150			
60647	55		85		45	1200			
60648	56	85	85			1250			
60649	57		85			1300			
60650	58		85			1350			
60651	60		90		47	1450			
60652	62	90	90			1550			
60653	63		90						
60654	65	95	95			1700			
60655	70		100		50	1700			
60656	75	100	105	85	55	3600			
63925	80		110			3700			

● I DIN 3129

CARACTERÍSTICAS / FEATURES / CARACTÉRISTIQUES

Cr-Mo

■ INCH

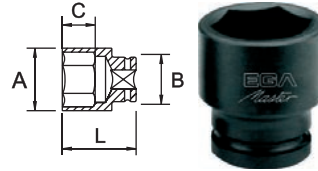

COD.	AF inch	L (mm)	A (mm)	B (mm)	C (mm)	Pt	g	Icon 1	Icon 2
58008	3/4		34			500			
58009	13/16		36		17				
58010	7/8	58	40	54					
58011	15/16		42		18	550			
65253	1		44		26				
65254	1.1/16		46						
65255	1.1/8		48			600			
65256	1.3/16		49			650			
65257	1.1/4	60	50			700			
65258	1.5/16				27				
57143	1.11/32		55			750			
65259	1.3/8								
65260	1.7/16					800			
65261	1.1/2	65	60						
65262	1.9/16				28	850			
65263	1.5/8		65						
65264	1.11/16	70	65						
65265	1.3/4					900			
65266	1.13/16		70	55	6	950	1		
65267	1.7/8	75				1000			
68690	1.15/16				32	1100			
65268	2		75						
68691	2.1/16	80	80			1400			
65269	2.1/8		80						
65270	2.1/4								
68692	2.5/16	85	85			1700			
65271	2.3/8								
68693	2.7/16	90	90		47	2000			
65272	2.1/2								
68694	2.9/16		95			2200			
65273	2.5/8	95	95			2250			
58012	2.11/16		97			2550			
58013	2.3/4		99			3250			
58014	2.13/16	100	101		53	3400			
58015	2.7/8		103	86		3500			
58016	2.15/16		104						

● I DIN 3129

CARACTERÍSTICAS / FEATURES / CARACTÉRISTIQUES

Cr-Mo

1"

■ 6 PT.

■ SERIE LARGA / LONG SOCKETS / SÉRIE LONGUE / LANGE SERIE / SERIE LUNGA / SERIE LONGA / ВЫСОКАЯ СЕРИЯ

■ MM

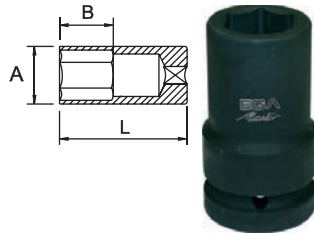

■ INCH

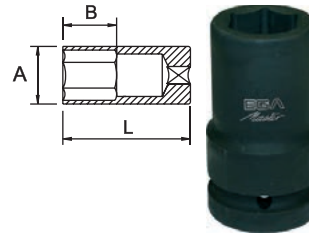

COD.	AF mm	L (mm)	A (mm)	B (mm)	Pt	g		
57386	20					700		
57387	21		40			750		
63898	22			16				
63899	23		41			800		
65539	24		42					
57388	25		43					
63900	26		44			900		
65540	27		46					
63905	28		47	19		950		
63901	29		48					
65541	30	90	49					
65542	32		50			1000		
63902	33							
63903	34		55		6		1	●
63904	35			23		1050		
65543	36		60			1100		
65544	38					1200		
57392	40					1300		
63883	41					1500		
63906	42		65			1600		
63907	43			40		1900		
65546	46		70			2500		
57393	47	100						
65547	50		75					
63908	55		80					
63909	60	120	90	50				

○ I DIN 3129

CARACTERÍSTICAS / FEATURES / CARACTÉRISTIQUES

Cr-Mo

COD.	AF inch	L (mm)	A (mm)	B (mm)	Pt	g		
57398	1		43			800		
57399	1.1/16		45	30		850		
58018	3/4		34			800		
58019	13/16	90	36	19		850		
58020	7/8		40			900		
58021	15/16		42					
65274	1.1/8		48					
65275	1.3/16		49	30		1200		
65276	1.1/4		50					
65277	1.5/16					1250		
65278	1.3/8		55	35		1300		
65279	1.7/16					1350		
65280	1.1/2		60		6	1400	1	●
65281	1.9/16					1450		
65282	1.5/8		65			1550		
65283	1.11/16	110				1600		
65284	1.3/4		70	42		1650		
65285	1.13/16					1700		
65286	1.7/8					1800		
57400	1.15/16		75			1750		
65287	2					1910		
58022	2.1/16		78			2050		
58023	2.1/8		80	57		2200		
58024	2.3/16		83			2400		
58025	2.1/4		86	58				
58026	2.5/16	120						
58027	2.3/8		87					

○ I DIN 3129

CARACTERÍSTICAS / FEATURES / CARACTÉRISTIQUES

Cr-Mo

1"

- 8 PT.
- STANDARD
- INCH

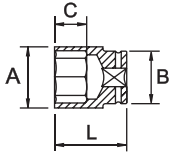

COD.	AF inch	L (mm)	A (mm)	B (mm)	C (mm)	Pt	g		
56377	7/8		50		15		695		
56378	15/16	60	52		18		700		
56379	1		54				715		
56380	1.1/8		59	54	19		820		
56381	1.3/16		61		21		850		
56382	1.1/4		63				860		
56383	1.5/16		66		22		905		
56384	1.3/8		68				1085		
56385	1.7/16	65	71	58	24	8	1200	1	
56386	1.1/2		73				1225		
56387	1.5/8	70	78				1365		
56388	1.11/16		82		27		1710		
56389	1.3/4		84				1720		
56390	1.13/16	75	86	62	30		1830		
56391	1.7/8		88				1850		
56392	2	80	94		32		2200		
56393	2.3/16	85	101		35		2655		

CARACTERÍSTICAS / FEATURES / CARACTÉRISTIQUES

Cr-V

PUNTAS ATORNILLADORAS DE IMPACTO CON VASO / IMPACT SOCKET BITS / EMBOUTS SUR DOUILLE MONOBLOC IMPACT / STECKSCHLÜSSEL BITS / INSERTI A BUSSOLA IMPACT / PONTAS APARAFUSADORAS DE IMPACTO COM CHAVE DE CAIXA / УДАРНАЯ ГОЛОВКА ДЛЯ БИТ
HEXAGONAL / HEXAGONAL / HEXAGONALE / HEXAGONAL / ESAGONALE / HEXAGONAL / ШЕСТИГРАННАЯ

N!

COD.	mm	L (mm)	g		
58741	10				
58742	12		700		
58743	14				
58744	17		750		
58745	19		800		
58746	22	100	850	10	
58747	24		900		
58748	27		950		
58749	30		1050		
58750	32		1250		



- 1.1/2"
- 6 PT.
- STANDARD
- MM

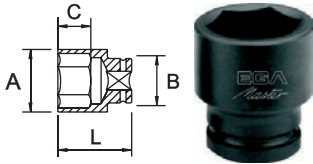

COD.	AF mm	L (mm)	A (mm)	B (mm)	C (mm)	Pt	Kg		
63884	34								
65666	35		60				2,2		
65737	36								
63885	38	80							
63886	40				31				
63887	41		70						
63888	42						2,4		
63889	43		75						
65426	46	85							
65427	50		80		33				
65428	55	90	85		36		2,7		
65429	60		90				2,8		
65430	65	95	95		39		3,2		
65431	70	100	105		40		3,5		
65432	75	105	110				4,0		
68697	77		115	85	42	6	4,5	1	-
65433	80						5,0		
65434	85	110	120		50		5,5		
65435	90		130				6,0		
65436	95		135				6,5		
65437	100	115	140		55		7,5		
65438	105	120	145				8,0		
65439	110	125	155		70		9,0		
65440	115	130	160		72		10		
65441	120	135	165		77		12		
65442	125	140	175				14		
65443	130	145	185				15		
65444	135	150	190		80		15,5		
65445	140	155	195						
65446	145	160	200						
65447	150	165	210						



CARACTERÍSTICAS / FEATURES / CARACTÉRISTIQUES

Cr-Mo

INCH

COD.	AF inch	L (mm)	A (mm)	B (mm)	C (mm)	Pt	Kg		
58029	1.5/16		62	86					
68700	1.3/8						2,2		
68701	1.7/16		65						
68702	1.1/2	80							
68703	1.9/16		70	85	31	6		1	-
68704	1.5/8						2,4		
68705	1.11/16		75						
68706	1.3/4	85							
68707	1.13/16								

COD.	AF inch	L (mm)	A (mm)	B (mm)	C (mm)	Pt	Kg		
68708	1.7/8		75						
68709	1.15/16	85			31		2,4		
68710	2		80						
68711	2.1/16								
68712	2.1/8		85						
68713	2.3/16				32		2,7		
68714	2.1/4	90							
68715	2.5/16		90						
68716	2.3/8						2,8		
68717	2.7/16				35				
68718	2.1/2	95							
68719	2.9/16		95				3,2		
68720	2.5/8		100						
68721	2.11/16				40				
68722	2.3/4	100					3,5		
68723	2.13/16		105						
68724	2.7/8								
68725	2.15/16	105		85	42		4,0		-
68726	3		110						
68727	3.1/16								
68728	3.1/8		115						
68729	3.3/16						4,5		
68730	3.1/4		120			6		1	
68731	3.5/16								
68732	3.3/8				50		5,0		
68733	3.7/16	110	125						
68734	3.1/2		130				5,5		
68735	3.9/16								
68736	3.5/8		135				6,0		
68737	3.11/16								
68738	3.3/4		140				6,5		
68739	3.13/16								
68740	3.7/8				55				
68741	3.15/16	115	140						
68742	4								
58030	4.1/8	120	146	86			9,0		
58031	4.3/16		148				10		
58032	4.1/4		151						
58033	4.5/16	124	153		70				
58034	4.3/8		156				11		
58035	4.7/16		158						
58036	4.1/2	128	160	127	72		12		
58037	4.5/8		163				13		
58038	4.3/4	132	166		77		14		
58039	5	136	175				16		



CARACTERÍSTICAS / FEATURES / CARACTÉRISTIQUES

Cr-Mo

1.1/2"

■ 6 PT.

■ SERIE LARGA / LONG SOCKETS / SÉRIE LONGUE / LANGE SERIE / SERIE LUNGA / SERIE LONGA / ВЫСОКАЯ СЕРИЯ

■ MM

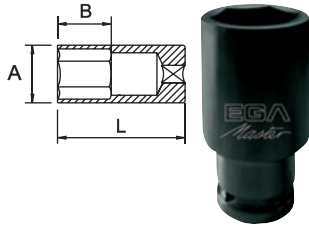

COD.	AF mm	L (mm)	A (mm)	B (mm)	Pt	Kg		
56100	34							
56101	35					2,8		
56102	36							
56103	38		60			2,9		
56104	40	120		31		3,0		
56105	41		70			3,2		
56106	42					3,3		
56107	43		75			3,8		
56108	46					4,0		
56109	50		80	33		4,5		
56110	55	150	85	36		5,0		
56111	60		90	39		5,5		
56112	65		95			6,5		
56113	70		105	40		7,0		
56114	75	170	110			7,5	1	●
56115	77		115	42	6	8,0		
56116	80					8,5		
56117	85		120	50		9,0		
56118	90	180	130	55		9,5		
56119	95		135			10		
56120	100		140			11		
56121	105		145	60		14		
56122	110		155			16		
56123	115	190	160			18		
56124	120		165	75		19		
56125	125		175			21		
56126	130		180			22		
56127	135		185	80		23		
56128	140	200	190			24		
56129	145		195			25		
56130	150		200	85				

○ I DIN 3129

CARACTERÍSTICAS / FEATURES / CARACTÉRISTIQUES

Cr-Mo

■ INCH

COD.	AF inch	L (mm)	A (mm)	B (mm)	Pt	Kg		
58041	1.5/16		62			2,7		
56131	1.3/8					2,8		
56132	1.7/16		65			2,9		
56133	1.1/2	120		31	6	3,0	1	●
56134	1.9/16		70			3,1		
56135	1.5/8					3,2		
56136	1.11/16		75					
56137	1.3/4							

COD.	AF inch	L (mm)	A (mm)	B (mm)	Pt	Kg		
56138	1.13/16					3,8		
56139	1.7/8		75	31		4,0		
56140	1.15/16			33		4,5		
56141	2		80			5,0		
56142	2.1/16			36		5,5		
56143	2.1/8		85			6,0		
56144	2.3/16					6,5		
56145	2.1/4	150				7,0		
56146	2.5/16		90			7,5		
56147	2.3/8			39		8,0		
56148	2.7/16					8,5		
56149	2.1/2		95			9,0		
56150	2.9/16					9,5		
56151	2.5/8					10		
56152	2.11/16		100			10,5		
56153	2.3/4			40		11		
56154	2.13/16		105			11,5		
56155	2.7/8	170				12		
56156	2.15/16					12,5		
56157	3		110	42		13		
56158	3.1/16					13,5		
56159	3.1/8		115		6	14	1	●
56160	3.3/16					14,5		
56161	3.1/4		120			15		
56162	3.5/16			50		15,5		
56163	3.3/8		125			16		
56164	3.7/16					16,5		
56165	3.1/2					17		
56166	3.9/16	180	130			17,5		
56167	3.5/8			55		18		
56168	3.11/16					18,5		
56169	3.3/4		135			19		
56170	3.13/16					19,5		
56171	3.7/8					20		
56172	3.15/16		140			20,5		
56173	4					21		
58042	4.1/16		143			21,5		
58043	4.1/8		146			22		
58044	4.3/16		148	60		22,5		
58045	4.1/4		151			23		
58046	4.5/16	190	153			23,5		
58047	4.3/8		156			24		
58048	4.1/2		160			24,5		
58049	4.5/8		163			25		
58050	4.3/4		166	77		25,5		

○ I DIN 3129

CARACTERÍSTICAS / FEATURES / CARACTÉRISTIQUES

Cr-Mo

09

LLAVES DE VASO
 SOCKET WRENCHES
 DOUILLES
 STECKSCHLÜSSEL
 BUSSOLE
 CHAVES DE CAIXA
 ГОЛОВКИ



- 2.1/2"
- 6 PT.
- STANDARD
- MM

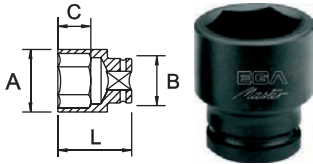

COD.	AF mm	L (mm)	A (mm)	B (mm)	C (mm)	Pt	Kg		
68817	41		80						
68818	42								
68819	46		85						
68820	50	120	90		36				
68821	55		95			7,5			
68822	60		100						
68823	65		105						
65452	70		110		40				
65453	75	125	120		45		8,0		
65454	80		125			8,5			
65455	85	130	130		50	9,0			
65456	90		135			11			
65457	95	140	140		55				
65458	100		145			13			
65459	105	145	155		60				
65460	110	155	160		65	15			
65461	115	160	165			16			
65462	120	160	175		70	18			
65463	125	165	180	130	75	19		1	-
65464	130	170	185			20			
65465	135	175	190			21			
65466	140	180	200		80	25			
65467	145	185	210			28			
65468	150	190			85	30			
65469	155	195	220			32			
65470	160	200	230			35			
65471	165					37			
65472	170	210	240		95	40			
65473	175					43			
65474	180		250			46			
65475	185	220	260		110	49			
65476	190		270			55			
65477	200		280			60			
68824	205					65			
68825	210				120				
68826	215	230	290						
68827	220		300						
68828	225		310						

DIN 3129

CARACTERÍSTICAS / FEATURES / CARACTÉRISTIQUES

Cr-Mo

2.1/2"

6 PT.

STANDARD

INCH

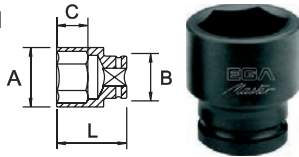

COD.	AF inch	L (mm)	A (mm)	B (mm)	C (mm)	Pt	Kg		
68744	2		90						
68745	2.1/16								
68746	2.1/8								
68747	2.3/16		95						
68748	2.1/4				36				
68749	2.5/16	120				7,5			
68750	2.3/8		100						
68751	2.7/16								
68752	2.1/2								
68753	2.9/16		105						
68754	2.5/8								
68755	2.11/16			40					
68756	2.3/4		110			7,6			
68757	2.13/16								
68758	2.7/8		115						
68759	2.15/16				45	7,7			
68760	3	125	120						
68761	3.1/16								
68762	3.1/8					7,8			
68763	3.3/16		125						
68764	3.1/4								
68765	3.5/16			50					
68766	3.3/8		130			8,4			
68767	3.7/16	130							
68768	3.1/2								
68769	3.9/16		135			8,8			
68770	3.5/8				130	6		1	-
68771	3.11/16								
68772	3.3/4		140		55	11			
68773	3.13/16	140							
68774	3.7/8		145						
68775	3.15/16								
68776	4		150		60				
68777	4.1/16								
68778	4.1/8	145	155			13			
68779	4.3/16								
68780	4.1/4								
68781	4.5/16	155	160		65				
68782	4.3/8								
68783	4.1/2		165			15			
68784	4.9/16								
68785	4.5/8	160	170		70				
68786	4.11/16								
68787	4.3/4		175			16			
68788	4.13/16								
68789	4.7/8	165	180		75	18			
68790	4.15/16								
68791	5	170	185			19			
68792	5.1/4								
68793	5.5/16	175							
68794	5.3/8		190		80				
68795	5.1/2	180	200			20			
68796	5.3/4	185	210		85				
68797	6								

COD.	AF inch	L (mm)	A (mm)	B (mm)	C (mm)	Pt	Kg		
68798	6.1/4		220						
68799	6.5/16			200	90	28			
68800	6.3/8		230						
68801	6.1/2					30			
68802	6.3/4	210	240		95	32			
68803	7					35			
68804	7.1/4		250		110				
68805	7.5/16					40			
68806	7.3/8	220	260						
68807	7.1/2			130	6	43		1	-
68808	7.3/4		270						
68809	8		280			49			
68810	8.1/4				120	55			
68811	8.5/16								
68812	8.3/8	230	290			60			
68813	8.1/2								
68814	8.3/4		300			65			
68815	9								

DIN 3129

CARACTERÍSTICAS / FEATURES / CARACTÉRISTIQUES

Cr-Mo

- 3.1/2"
- 6 PT.
- STANDARD
- MM

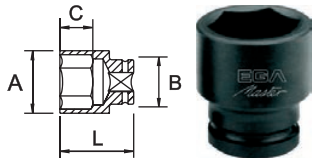

■ INCH

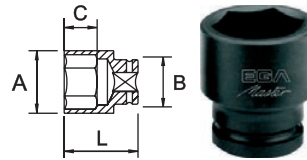

COD.	AF mm	L (mm)	A (mm)	B (mm)	C (mm)	Pt	Kg		
67500	100		170				16		
67501	105	180	175		100		17		
67502	110		185				21		
67503	115	200	190		115		24		
67504	120		195				25		
67505	125		200	180	120		28		
67506	130	210	210				30		
67507	135		220		125		34		
67508	140		220		130		37		
67509	145		230				39		
67510	150	220					43		
67511	155		240		135		45		
67512	160		250		140		50		
67513	165	230	260				55		
67514	170		270	200	145		60		
67515	175		270						
67516	180		280		150				
67517	185	240					65		
67518	190		290		155	6		1	-
67519	195		300				70		
67520	200		310		160		80		
67521	205	250							
67522	210		320				85		
67523	215		330		165				
67524	220		340		170		90		
67525	225	260					95		
67526	230		350		175		105		
67527	235	270	360				110		
67528	240		370	230	185				
67529	245						115		
67530	250	280	380		190		120		
67531	255		390				125		
67532	260		400		195		130		
67533	265	290					135		
67534	270		410				140		
67535	275		420		200		145		
67536	280	300	430				150		



CARACTERÍSTICAS / FEATURES / CARACTÉRISTIQUES

Cr-Mo

COD.	AF inch	L (mm)	A (mm)	B (mm)	C (mm)	Pt	Kg		
68830	4		170				16		
68831	4.1/16		175						
68832	4.1/8						17		
68833	4.3/16	180	180		100				
68834	4.1/4		180						
68835	4.5/16		185				21		
68836	4.3/8								
68837	4.1/2								
68838	4.9/16		190				24		
68839	4.5/8								
68840	4.11/16		195	180	115				
68841	4.3/4	210					25		
68842	4.13/16		200						
68843	4.7/8								
68844	4.15/16						28		
68845	5		210		120				
68846	5.1/4						30		
68847	5.5/16								
68848	5.3/8	220	220		125		34		
68849	5.1/2				130		37		
68850	5.3/4		230		135		43		
68851	6		240						
68852	6.1/4								
68853	6.5/16	230	250		140	6	50	1	-
68854	6.3/8								
68855	6.1/2		260				55		
68856	6.3/4		270	200	145		60		
68857	7								
68858	7.1/4	240	280						
68859	7.5/16				150		66		
68860	7.3/8		290						
68861	7.1/2								
68862	7.3/4	250	300		155		70		
68863	8		310		160		80		
68864	8.1/4								
68865	8.5/16		320				85		
68866	8.3/8	260			165				
68867	8.1/2		330				90		
68868	8.3/4				170				
68869	9		350				105		
68870	9.1/4	270		230	175				
68871	9.5/16		360				110		
68872	9.3/8								
68873	9.1/2		370		185				
68874	9.3/4	280	380				115		
68875	10		390		190		125		
68876	10.1/4	290	400		195		130		



CARACTERÍSTICAS / FEATURES / CARACTÉRISTIQUES

Cr-Mo

ADAPTADOR / ADAPTER / ADAPTATEUR / VERBINDUNGSTEIL / ADATTATORE / REDUTOR / АДАПТЕР

COD.	AF inch	AF inch	g		
60696	3/8-1/2		50		
60698	1/2-3/8		110		
60699	1/2-3/4		130		
60700	3/4-1/2		370		
60701	3/4-1		410		
60702	1-3/4		600	6	•
68698	1-1.1/2		1100		
65448	1.1/2-1		2100		
65449	1.1/2-2.1/2		4000		
65478	2.1/2-1.1/2		4500		

DIN 3121

ARTICULACIÓN UNIVERSAL / UNIVERSAL JOINT / CARDAN UNIVERSEL / KARDANGELNENK / SNODO CARDANICO / CARDAN UNIVERSAL / ШАРНИР

COD.	AF inch	g		
60704	3/8	80		
60705	1/2	180	6	•

DIN 3121



COD.	AF inch	g		
60706	3/4	600	4	
60707	1	1250	2	
60708	1.1/2	3000		•
60709	2.1/2	6000	1	

DIN 3121

ALARGADERA / EXTENSION / RALLONGE / VERLÄNGERUNG / PROLUNGA / EXTENÇÃO / УДЛИНИТЕЛЬ

COD.	AF inch	L (mm)	g		
60710	3/8	75	80		
60711		125	220		
60713	1/2	250	430		
57368		100	450	6	
60714	3/4	175	850		
57369		250	1050		•
60716		175	1500		
57402	1	250	1850	4	
60717		330	2550		
65450		250	5500		
65451	1.1/2	300	6500	1	

DIN 3121

ANILLA DE SEGURIDAD / SECURITY O-RING / BAGUES DE SECURITE / SICHERUNGSRING / ANELLO SPACCATO / ANEL DE SEGURANÇA / БЕЗОПАСНОЕ КОЛЬЦО

COD.	AF inch	Rango (mm) / Range (mm) / Rang (mm)	g	
60724	3/4	17-46	5,0	
60725		50		
63274		24-38		
60726	1	38-70	10	
60727		75		6
60783	1.1/2	34-150		
63275		41-70		
60784	2.1/2	70-200	20	
63276		200-225		



3.1/2"

PASADOR DE SEGURIDAD / SECURITY PIN / GOUPILLE DE SECURITE / SICHERUNGSTIFT / COPPIGLIA / PINO DE SEGURANÇA / ФИКСИРУЮЩИЙ ПАЛЕЦ

COD.	AF inch	Rango (mm) / Range (mm) / Rang (mm)	g	
60732	3/4	17-46	10	
60733		50		
63277		24-38		
60734	1	38-70	15	6
60735		75		
60767	1.1/2	34-110	20	
61054		110-150		
63278	2.1/2	41-70	25	
60768		70-200		
63279		200-225		

JUEGOS / SETS / COFRETS / SÄTZE / ASSORTIMENTI / JOGOS / НАБОРЫ

1/2"

STANDARD

MM

COD.	AF inch	PCS.	Pt	Kg
60693	1/2	10	6	3,5



Composición / Composition / Composition	Descripción / Description / Description	
60606, 60607, 60609, 60610, 60612, 60613, 60614, 60615, 60616, 60618	Llaves de vaso / Socket wrenches	13-14-16-17-19-21-22-24-27-30 mm

COD.	AF inch	PCS.	Pt	Kg
61265	1/2	10	6	3,0

Composición / Composition / Composition	Descripción / Description / Description	
60603, 60604, 60605, 60606, 60607, 60610, 60612, 60613, 60614, 60615	Llaves de vaso / Socket wrenches	10-11-12-13-14-17-19-21-22-24 mm

INCH

COD.	AF inch	PCS.	Pt	Kg
61267	1/2	11	6	3,2



Composición / Composition / Composition	Descripción / Description / Description	
65213, 65214, 65215, 65216, 65217, 65218, 65219, 65220, 65221, 65222, 65223	Llaves de vaso / Socket wrenches	3/8"-7/16"-1/2"-9/16"-5/8"-11/16"-3/4"-13/16"-7/8"-15/16"-1"

SERIE LARGA / LONG SOCKETS / SÉRIE LONGUE / LANGE SERIE / SERIE LUNGA / SERIE LONGA / ВЫСОКАЯ СЕРИЯ

MM

COD.	AF inch	PCS.	Pt	Kg
61266	1/2	10	6	4,0



Composición / Composition / Composition	Descripción / Description / Description	
60660, 60661, 60662, 60663, 60664, 60666, 60668, 60669, 60670, 60672	Llaves de vaso serie larga / Long socket wrenches	10-11-12-13-14-17-19-21-22-24 mm

INCH

COD.	AF inch	PCS.	Pt	Kg
61268	1/2	11	6	4,2



Composición / Composition / Composition	Descripción / Description / Description	
55630, 55631, 55632, 55633, 55634, 55635, 55636, 55637, 55638, 55639, 55640	Llaves de vaso serie larga / Long socket wrenches	3/8"-7/16"-1/2"-9/16"-5/8"-11/16"-3/4"-13/16"-7/8"-15/16"-1"

- 3/4"
- STANDARD
- MM

COD.		PCS.	Pt	
60694	3/4	8	6	5,0

Composición / Composition / Composition	Descripción / Description / Description		
60625, 60626, 60628, 60629, 60630, 60632, 60633, 60634	Llaves de vaso / Socket wrenches	26-27-29-30-32-34-36-38 mm	



COD.		PCS.	Pt	
61269	3/4	8	6	5,0

Composición / Composition / Composition	Descripción / Description / Description		
60621, 60622, 60624, 60626, 60629, 60630, 60633, 60635	Llaves de vaso / Socket wrenches	21-22-24-27-30-32-36-41 mm	

- INCH

COD.		PCS.	Pt	
61271	3/4	8	6	5,0

Composición / Composition / Composition	Descripción / Description / Description		
65231, 65232, 65233, 65235, 65236, 65237, 65238, 65239	Llaves de vaso / Socket wrenches	1"-1.1/16"-1.1/8"-1.1/4"-1.5/16"-1.3/8"-1.7/16"-1.1/2"	



- SERIE LARGA / LONG SOCKETS / SÉRIE LONGUE / LANGE SERIE / SERIE LUNGA / SERIE LONGA / ВЫСОКАЯ СЕРИЯ



- MM

COD.		PCS.	Pt	
61270	3/4	8	6	6,0

Composición / Composition / Composition	Descripción / Description / Description		
60680, 60681, 60682, 60684, 60685, 60686, 60689, 60691	Llaves de vaso serie larga / Long socket wrenches	21-22-24-27-30-32-36-41 mm	





- INCH

COD.		PCS.	Pt	
61272	3/4	8	6	6,0

Composición / Composition / Composition	Descripción / Description / Description		
65245, 65246, 65247, 65249, 65250, 65251, 65252	Llaves de vaso serie larga / Long socket wrenches	1"-1.1/16"-1.1/8"-1.1/4"-1.5/16"-1.3/8"-1.7/16"-1.1/2"	





- 1"
- STANDARD
- MM

COD.		PCS.	Pt	
61273	1	9	6	7,5
Composición / Composition / Composition		Descripción / Description / Description		
65534, 65535, 65536, 65537, 65538, 60640, 60641, 60643, 60644		Llaves de vaso / Socket wrenches		24-27-30-32-36-38-41-46-50 mm 





- INCH

COD.		PCS.	Pt	
61275	1	9	6	7,5
Composición / Composition / Composition		Descripción / Description / Description		
65253, 65255, 65257, 65258, 65261, 65263, 65265, 65267, 65268		Llaves de vaso / Socket wrenches		1"-1.1/8"-1.1/4"-1.5/16"-1.1/2"-1.5/8"-1.3/4"-1.7/8"-2" 





- SERIE LARGA / LONG SOCKETS / SÉRIE LONGUE / LANGE SERIE / SERIE LUNGA / SERIE LONGA / ВЫСОКАЯ СЕРИЯ

- MM

COD.		PCS.	Pt	
61274	1	9	6	7,5
Composición / Composition / Composition		Descripción / Description / Description		
65539, 65540, 65541, 65542, 65543, 65544, 63883, 65546, 65547		Llaves de vaso serie larga / Long socket wrenches		24-27-30-32-36-38-41-46-50 mm 



- INCH

COD.		PCS.		Pt
61276	1	9	11	6
Composición / Composition / Composition		Descripción / Description / Description		
65274, 65276, 65277, 65280, 65282, 65284, 65286, 65287		Llaves de vaso serie larga / Long socket wrenches		1"-1.1/8"-1.1/4"-1.5/16"-1.1/2"-1.5/8"-1.3/4"-1.7/8"-2" 